

# NNH-Instrumentarium

## Sinus Instruments



Quality you can rely on

**30**  
Years  
SPIGGLE & THEIS  
1994 - 2024





# Über uns

---

# About Us

## Herzlich willkommen in unserem Instrumentenkatalog.

Bevor Sie in die Welt unserer ‚MADE IN GERMANY‘ Instrumente eintauchen, möchten wir Ihnen einen kurzen Einblick in unsere Erfolgsgeschichte gewähren.

Was vor 30 Jahren als überschaubares Handelsunternehmen begann, hat sich seitdem zu einem weltweit etablierten Hersteller erstklassiger **HNO-Instrumente und Verbrauchsmaterialien** entwickelt.

**Unsere Geschichte** ist geprägt von einer tiefen Hingabe zur Hals-, Nasen- und Ohrenchirurgie sowie von kontinuierlicher Weiterentwicklung. **Unsere Leidenschaft** zur HNO spiegelt sich wider in der Partnerschaft mit den medizinischen Fachkräften, die ein integraler Bestandteil unseres Netzwerks und unserer Innovationskraft sind.

Einen weiteren Schlüssel unseres Erfolges stellen **unsere Mitarbeiter** dar, von denen einige bereits seit Jahrzehnten Teil unseres Unternehmens sind. Ihre Fachkompetenz und kontinuierlicher Einsatz haben es uns ermöglicht, zusammen mit Ihnen neue Produkte zu entwickeln und fortlaufend zu verbessern.

2020 ist die **SPIGGLE & THEIS Medizintechnik GmbH** mehrheitlich von der **Thyssen'schen Handelsgesellschaft** übernommen worden, wodurch der weitere Ausbau des Unternehmens, unter Berücksichtigung unserer Innovationskraft und des Qualitätsversprechens, sichergestellt ist. Mit diesem starken Partner an unserer Seite eröffnen sich neue Horizonte, die uns unsere Visionen schneller umsetzen lassen und den Kundenanforderungen noch besser gerecht werden.

Dieser Katalog präsentiert **hochwertige Instrumente**, die auf den Bedürfnissen unserer Kunden und Partner aus der HNO-Medizin basieren. Wir hoffen, dass Sie unser Produktportfolio überzeugt und Sie hier das passende Instrument für Ihre Anforderung finden.

Wir danken Ihnen herzlich für Ihre **Treue** und Ihr **Vertrauen**.

**Ihr SPIGGLE & THEIS Team**

## Welcome to our instrument catalog.

Before you immerse yourself in the world of our ‚MADE IN GERMANY‘ instruments, allow us to offer a brief glimpse into our success story.

What began as a modest trading company three decades ago has since developed into a globally recognized manufacturer of top-tier **ENT instruments and consumables**.

**Our history** is defined by a profound dedication to ENT surgery, healing practices, and continuous growth. **Our passion** resonates perfectly with the physicians, specialists, and medical professionals who are integral to our network and innovative spirit.

Another vital aspect of our success is **our employees**, some of whom have been with our company for decades. Their expertise and unwavering dedication have empowered us to collaborate with you in developing and consistently enhancing new products.

In 2020, **SPIGGLE & THEIS Medizintechnik GmbH** was primarily acquired by **Thyssen'sche Handelsgesellschaft**, ensuring the company's continued expansion while prioritizing our innovative capacity and commitment to quality. With this robust partnership at our side, new horizons have emerged, accelerating the realization of our visions and enhancing our ability to meet customer demands more efficiently.

This catalog showcases **premium instruments** tailored to the needs of our clients and partners in the field of ENT medicine. We hope you discover the perfect instrument that meets your requirements and allows our commitment to quality to speak for itself.

Thank you very much for your **loyalty** and **trust**.

**Your SPIGGLE & THEIS Team**





## Inhaltsverzeichnis

### Table of contents

01	Ambulantes Nasen-Nebenhöhlen-Instrumentarium / Diagnostic Sinus Instruments .....	5 - 8
02	Endoskopie und Videodokumentation / Endoscopy and Video Documentation .....	9 - 17
03	Septum-Instrumente / Septum-Instruments .....	18 - 28
04	FESS-Instrumente / FESS-Instruments .....	29 - 40
05	Dieler bipolare Koagulationszangen / Dieler bipolar coagulation forceps .....	41 - 44
06	Stirnhöhlen- und Keilbeinhöhlen-Instrumente / Frontal and Sphenoidal Instruments .....	45 - 51
07	Mikroskopische / Endoskopische Instrumente für die Pansinus-Chirurgie Microscopic / Endoscopic Instruments for Pansinus Surgery .....	52 - 62
08	Allgemeines / Miscellaneous .....	63 - 67
09	Sterilisationssysteme / Sterilization Systems .....	68 - 69
10	Sets .....	70 - 72
	Index.....	73 - 76

#### Attention:

Not every instrument is available in all markets. Availability depends on local regulations. Please contact your SPIGGLE & THEIS representative or distributor, if you have any questions about the availability of our products in your region.

## 01 Ambulantes Nasen-Nebenhöhlen-Instrumentarium

### Diagnostic Sinus Instruments

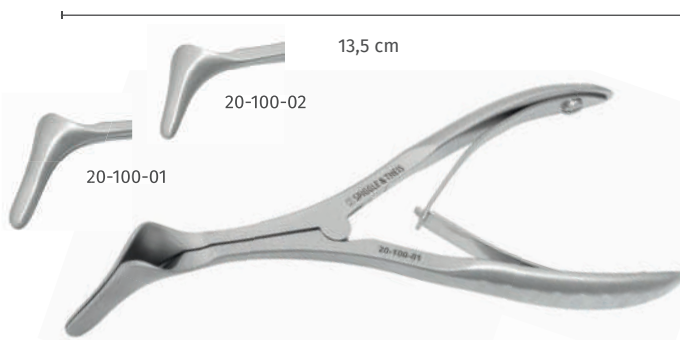

**Hartmann Nasenspekulum, 13,5 cm**  
Hartmann nasal speculum, 13.5 cm

Art.-Nr./No.		Länge / Length (cm)
20-100-01	Für Erwachsene for adults	13,5
20-100-02	Für Jugendliche & Kinder for juveniles & children	13,5



**Eicken Spülröhrchen, lange Biegung, biegsam, 13,8 cm**  
Eicken antrum cannula, long curve, bendable, 13.8 cm

Art.-Nr./No.		AD / OD (mm)
30-100-25		2,5
30-100-30		3,0
30-100-40		4,0

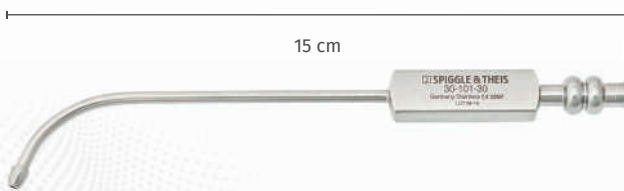

**Eicken Spülröhrchen, lange Biegung, 15 cm**  
Eicken antrum cannula, long curve, 15 cm

Art.-Nr./No.		AD / OD (mm)
30-101-25		2,5
30-101-30		3,0
30-101-40		4,0

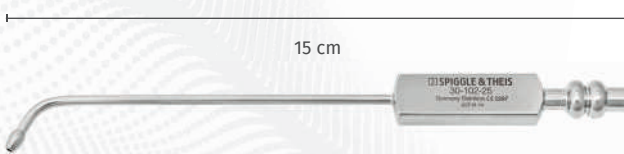

**Eicken Spülröhrchen, kurze Biegung, 15 cm**  
Eicken antrum cannula, short curve, 15 cm

Art.-Nr./No.		AD / OD (mm)
30-102-25		2,5
30-102-30		3,0
30-102-40		4,0



## 01 Ambulantes Nasen-Nebenhöhlen-Instrumentarium Frazier Saugrohr

### Diagnostic Sinus Instruments Frazier suction tube

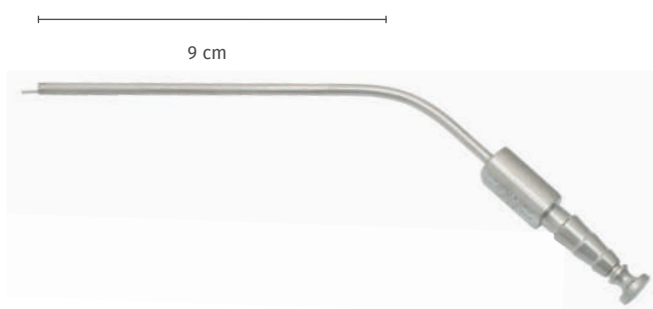

**mit Griffplatte und Unterbrecher, 9 cm**  
with suction control, 9 cm

Art.-Nr. Art.-No.	AD / OD Ch / Fr	AD / OD mm
30-080-05	5	1,7
30-080-06	6	2,0
30-080-07	7	2,3
30-080-08	8	2,7
30-080-09	9	3,0
30-080-10	10	3,3
30-080-12	12	4,0
30-080-15	15	5,0

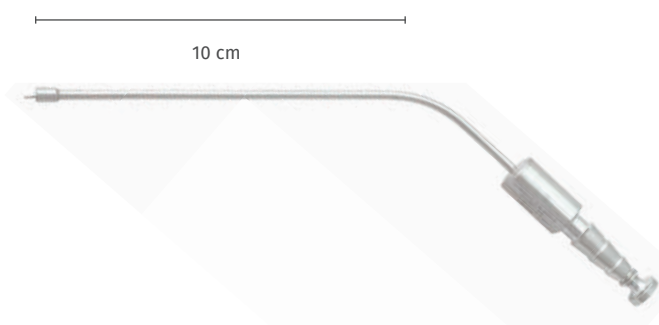

**kniegebogen, Knopfende, 10 cm / angled, ball ended, 10 cm**

Art.-Nr. Art.-No.	AD / OD Ch / Fr	AD / OD mm
30-082-08	8	2,7
30-082-10	10	3,3
30-082-12	12	4,0
30-082-15	15	5,0

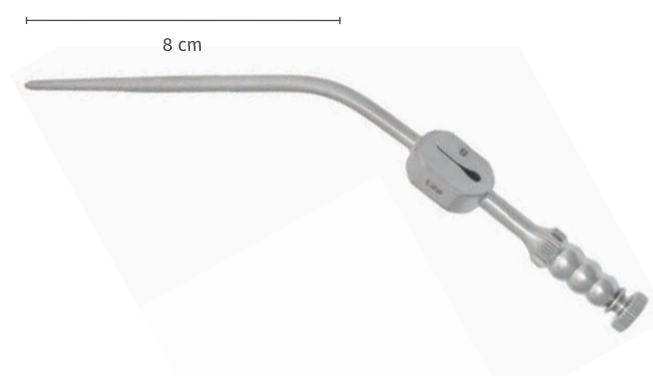

**konisch, mit tränenförmiger Sogsteuerung, 8 cm**  
conical, with tear formed suction control, 8 cm

Art.-Nr. Art.-No.	AD / OD Ch / Fr	AD / OD mm
30-105-06	6	2,0
30-105-08	8	2,7
30-105-10	10	3,3

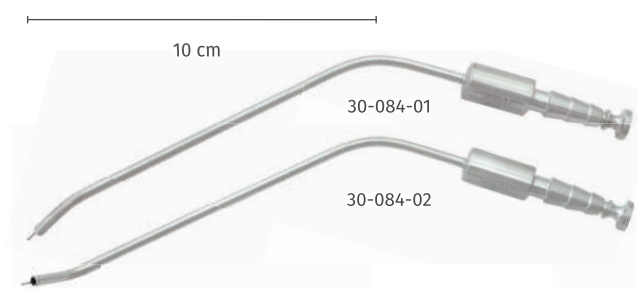

**mit Unterbrecher, 10 Ch (3,3 mm), 10 cm**  
with suction control, 10 Ch (3,3 mm), 10 cm

Art.-Nr./No.	Beschreibung / Description
30-084-01	rechts gebogen / curved right
30-084-02	links gebogen / curved left

## 01 Ambulantes Nasen-Nebenhöhlen-Instrumentarium

### Diagnostic Sinus Instruments

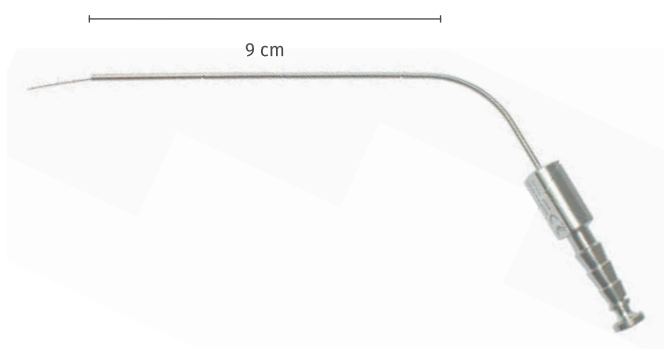

**Ferguson Saugrohr mit Griffplatte und Unterbrecher, 9 cm**  
Ferguson suction tube with suction control, 9 cm

Art.-Nr. Art.-No.	AD / OD Ch / Fr	AD / OD mm
30-081-06	6	2,0
30-081-08	8	2,7

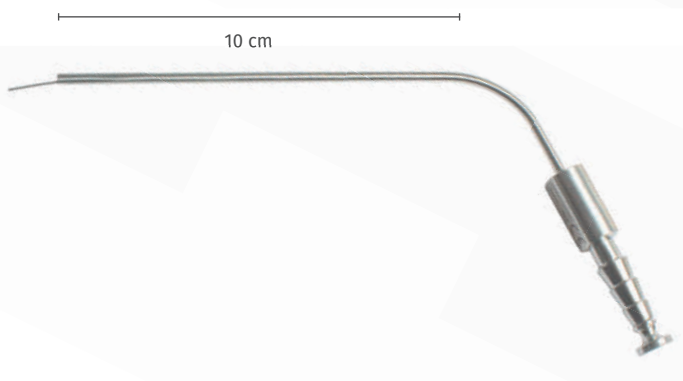

**Ferguson Saugrohr mit Griffplatte und Unterbrecher, 10 cm**  
Ferguson suction tube with suction control, 10 cm

Art.-Nr. Art.-No.	AD / OD Ch / Fr	AD / OD mm
30-081-09	9	3,0
30-081-10	10	3,3
30-081-12	12	4,0
30-081-15	15	5,0



**Stirnhöhlen-Saugrohr, biegsam, 16,5 cm**  
Frontal sinus suction tube, bendable, 16.5 cm

Art.-Nr./No.	AD / OD (mm)
30-106-25	2,5
30-106-30	3,0
30-106-40	4,0



**Stirnhöhlen Saugraspatorium, gebogen, biegsam, mit Sogsteuerung, 10 cm**  
Frontal sinus suction raspatorium, curved, bendable, with suction control, 10 cm

**30-108-00**

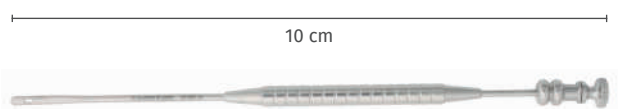

**Gourney Sauglevatorium, 3 mm, 19 cm**  
Gourney suction elevator, 3 mm, 19 cm

**20-320-19**



## 01 Ambulantes Nasen-Nebenhöhlen-Instrumentarium

### Diagnostic Sinus Instruments

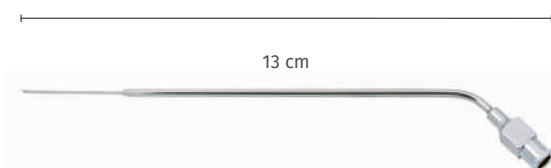

**Injektionskanüle, kniegebogen, AD 0,8 mm, 13 cm**  
Injection needle, angled, OD 0.8 mm, 13 cm

**30-122-08**



**Ritter Stirnhöhlenbougie, 15,5 cm**  
Ritter frontal sinus bougie, 15.5 cm

Art.-Nr./No.	AD / OD (mm)
30-121-25	2,5
30-121-30	3,0



**Biopsiezange, gerade, doppelbeweglich, Löffel 2x4 mm, AD 2,5 mm, Arbeitslänge 15 cm, mit Spülkanal**  
Biopsy forceps, straight, double-action, cup 2x4 mm, OD 2.5 mm, working length 15 cm, with irrigation channel

**30-125-00**



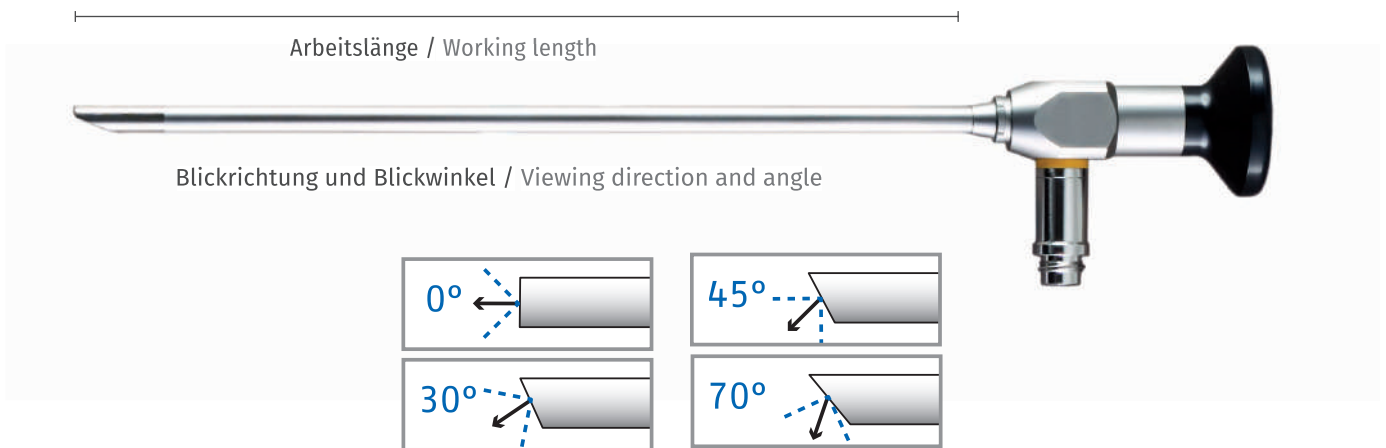

#### Vorteile unserer Endoskope:

- Kompatibel mit allen Lichtquellen auf dem Markt (universalkompatibel)
- Extrem robuste Rohrkonstruktion mit verstärktem 2-Rohr-Edelstahl-System
- Hochwertig vergütetes, hochauflösendes Linsen-System
- Optische Saphirglas-Frontlinse, kratzfest und hitzebeständig fixiert mit Epoxidharz
- Hitzebeständiges Polymer-Okular (PEEK)
- Hohe Dichtigkeit durch gelaserte Schnittstellen
- Mehr Bildinformation durch großen Öffnungswinkel
- Hohe Bildschärfe im gesamten Bildbereich
- Gleichmäßige Helligkeit bis zum Rand durch Lichtkonus
- Autoklavierbar
- 24 Monate Garantie

#### Advantages of our endoscopes:

- Compatible to all light sources available (universal camera compatible)
- Extremely robust stainless steel tube construction with reinforced outer tube
- High precision quality lens system
- Optical sapphire glass front lens, scratch resistant and fixed with heat-resistant epoxide
- Heat-resistant polymer ocular (PEEK)
- Tight sealing due to laser welded joints
- More image information due to wide viewing angle
- High focus quality in entire viewing area
- Constant brightness up to the edge of viewing area
- Autoclavable
- 24 months guarantee



**All unsere Endoskope sind aus Phynoxstahl**  
für verbesserten Schutz gegen Verbiegen und Bruch

**All our endoscopes are made of phynox steel**  
for improved protection against bending or break

## 02 Endoskopie und Videodokumentation Sinuskop, HD

### Endoscopy and Video Documentation Sinuscope, HD

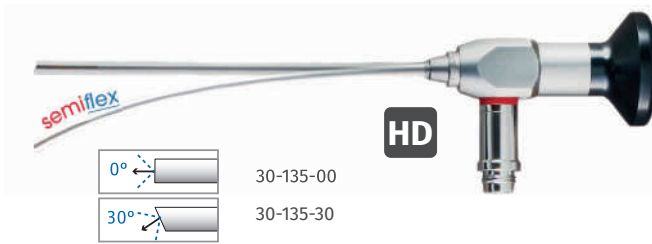

**semiflex, autoklavierbar, AD 2,7 mm, 11 cm**  
**semiflex, autoclavable, OD 2.7 mm, 11 cm**

Art.-Nr./No.	Winkel / Angle
30-135-00	0°
30-135-30	30°

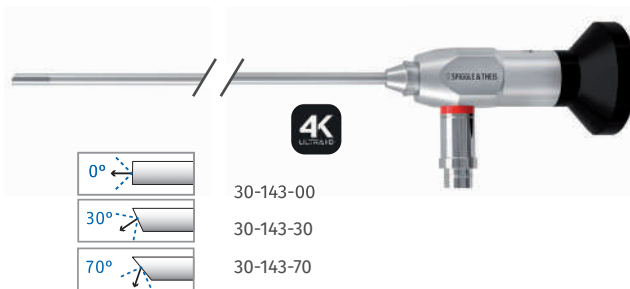

**4K, starr, autoklavierbar, AD 4,0 mm, 17,5 cm**  
**4K, rigid, autoclavable, OD 4.0 mm, 17.5 cm**

Art.-Nr./No.	Winkel / Angle
30-143-00	0°
30-143-30	30°
30-143-70	70°

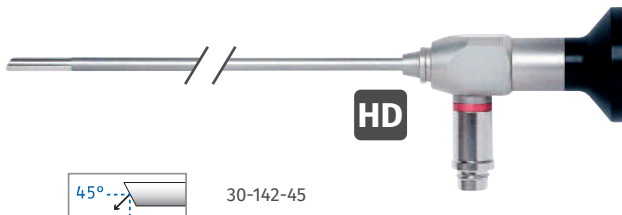

**starr, autoklavierbar, AD 4,0 mm, 17,5 cm**  
**rigid, autoclavable, OD 4.0 mm, 17.5 cm**

Art.-Nr./No.	Winkel / Angle
30-142-45	45°
30-142-90	90°

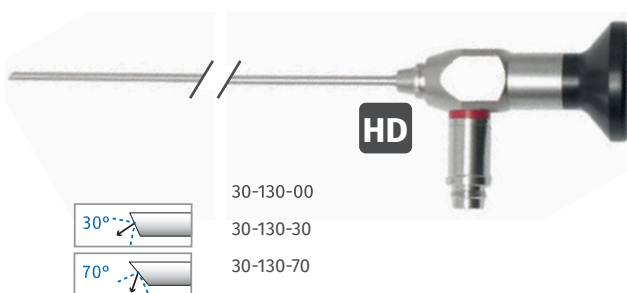

**starr, autoklavierbar, AD 2,7 mm, 18,75 cm**  
**rigid, autoclavable, OD 2.7 mm, 18.75 cm**

Art.-Nr./No.	Winkel / Angle
30-130-00	0°
30-130-30	30°
30-130-70	70°

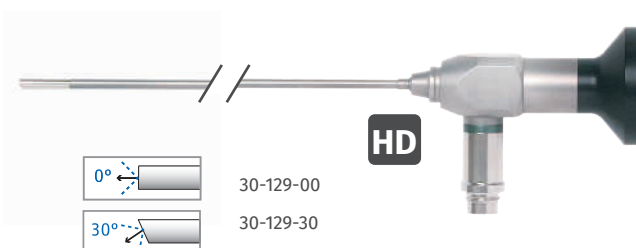

**starr, autoklavierbar, AD 2,7 mm, 11 cm**  
**rigid, autoclavable, OD 2.7 mm, 11 cm**

Art.-Nr./No.	Winkel / Angle
30-134-00	0°
30-134-30	30°

## 02 Endoskopie und Videodokumentation

### Endoscopy and Video Documentation

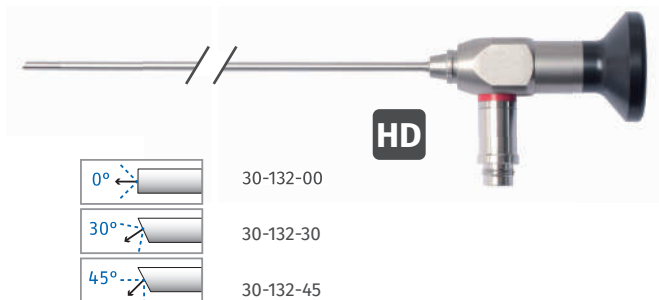

starr, autoklavierbar, AD 2,7 mm, 14,1 cm  
rigid, autoclavable, OD 2.7 mm, 14.1 cm

Art.-Nr./No.	Winkel / Angle
30-132-00	0°
30-132-30	30°
30-132-45	45°

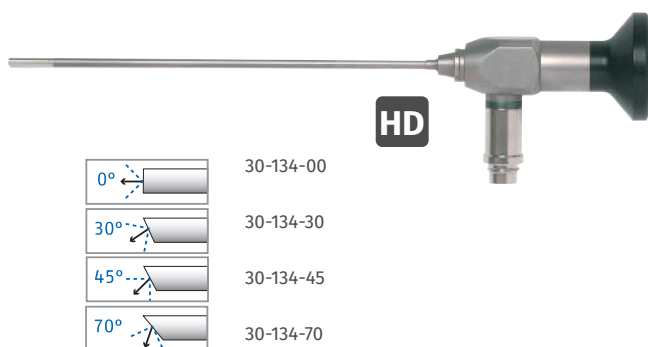

starr, autoklavierbar, AD 2,7 mm, 11 cm  
rigid, autoclavable, OD 2.7 mm, 11 cm

Art.-Nr./No.	Winkel / Angle
30-134-00	0°
30-134-30	30°
30-134-45	45°
30-134-70	70°



#### Sterilisations-Container für Endoskope

Ø 2,5 - 5,0 mm, Länge bis zu 19,5 cm

Sterilizing & protecting tray for endoscopes

Ø 2.5 - 5.0 mm, up to 19.5 cm length

Art.-Nr./No.	
80-621-05	für 2 Endoskope / for 2 endoscopes
80-622-56	für 6 Endoskope, 1 Lichtkabel for 6 endoscopes, 1 light-cable
80-623-22	für 2 Endoskope, 1 Lichtkabel, 1 Kamerakopf for 2 endoscopes, 1 light-cable, 1 camera head



## 02 Endoskopie und Videodokumentation

### Endoscopy and Video Documentation



**Endoskop-Handgriff, rund, Edelstahl, Griffmulde, 11 cm**  
Endoscope handle, round, stainless steel, moulded grip, 11 cm

Art.-Nr./No.	Beschreibung / Description
30-151-27	für 2,7 mm Endoskope for 2.7 mm endoscopes
30-151-40	für 4,0 mm Endoskope for 4.0 mm endoscopes

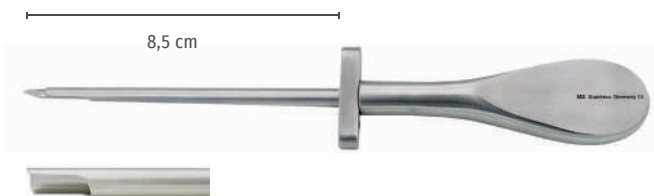

**Antrum-Trocar, schnabelförmig, 5,0 x 4,0 mm, AL 8,5 cm, für 4 mm Endoskope**  
Antrum trocar, beaked, 5.0 x 4.0 mm, WL 8.5 cm, for 4 mm endoscopes

**30-155-50**

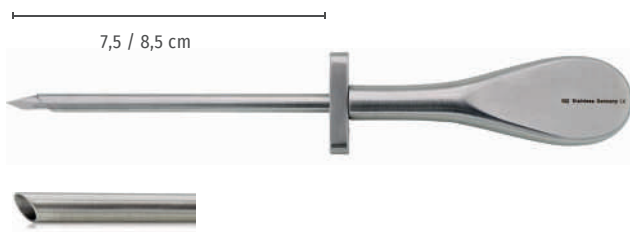

**Antrum-Trocar, schräges Ende, für Endoskope**  
Antrum trocar, oblique tip, for endoscopes

Art.-Nr./No.	Beschreibung / Description
30-156-33	3,3 x 2,8 mm, AL 7,5 cm, für 2,7 mm Endoskope 3,3 x 2,8 mm, WL 7.5 cm, for 2.7 mm endoscopes
30-156-40	4,0 x 3,0 mm, AL 8,5 cm, für 3,0 mm Endoskope 4,0 x 3,0 mm, WL 8.5 cm, for 3.0 mm endoscopes
30-156-50	5,0 x 4,0 mm, AL 8,5 cm, für 4,0 mm Endoskope 5,0 x 4,0 mm, WL 8.5 cm, for 4.0 mm endoscopes



**Ultra-Stop Antibeschlagmittel / Ultra-Stop Anti-Fog solution**

Art.-Nr./No.	Beschreibung / Description
30-160-01	25 ml Pipettenflasche, unsteril 25 ml pipette bottle, non-sterile
30-160-02	30 ml Durchstichflasche, steril 30 ml pierce bottle, sterile
30-160-03	15 ml Sprayflasche, unsteril 15 ml spray bottle, non-sterile

## 02 Endoskopie und Videodokumentation

---

### Endoscopy and Video Documentation



**Anti-Fog Antibeschlag-Satz, steril, 48 Stück/Box**  
**Anti-Fog Solution Kit, sterile, 48 pieces/box**

**30-160-05**



**Saug- und Spülhandgriff für Endoskope**  
**Suction and irrigation handle for endoscopes**

**30-161-00**







#### LED-Leuchtgriffe / LED light handles

Art.-Nr./No.

70-211-00 LED-Hochleistungs-Leuchtgriff, 230 V, bestehend aus: (70-211-10, 70-211-20, 70-211-30, 70-211-40)  
LED high performance light-handle, 230 V, consisting of: (70-211-10, 70-211-20, 70-211-30, 70-211-40)

70-211-01 LED-Hochleistungs-Leuchtgriff, 120 V, bestehend aus: (70-211-10, 70-211-20, 70-211-30, 70-211-50)  
LED high performance light-handle, 120 V, consisting of: (70-211-10, 70-211-20, 70-211-30, 70-211-50)

70-211-10 LED-Handgriff, schwarz, mit Helligkeitsdimmer, Ausschaltautomatik, 3 W, 5500° K, 17500 Lux, zur Verwendung mit Li-Io-Akku 3,7 V und Endoskop-Adapter, 50 Std. Brenndauer  
LED light handle, black, with brightness dimmer, automatic switch-off, 3 W, 5500° K, 17500 lux, to use with Li-ion chargeable battery 3.7 V and endoscope adapter, 50 hours run-time

70-211-20 Li-Ionen-Akku, 3,7 V, für LED-Handgriff  
Li-ion rechargeable battery, 3.7 V, for LED light-handle

70-211-30 Endoskopie-Adapter für LED-Handgriff, passend für Standardgewinde an Endoskopen (AcMI-Gewinde)  
Endoscope adapter for LED light-handle, fits standard endoscope threads (AcMi-thread)

70-211-40 Ladegerät für bis zu 2 LED-Handgriffe, 3,5 V, 230 V, Standgerät, Wandhalterung  
Charging base for up to 2 LED light-handles, 3.5 V, 230 V, table model, with wall holder

70-211-50 Ladegerät für bis zu 2 LED-Handgriffe, 3,5 V, 120 V, Standgerät, Wandhalterung  
Charging base for up to 2 LED light-handles, 3.5 V, 120 V, table model, with wall holder

## 02 Endoskopie und Videodokumentation, Flexibles Nasopharyngoskop

### Endoscopy and Video Documentation, Flexible Nasopharyngoscope

Arbeitslänge	32 cm
Working length	32 cm
Abwinkelung (auf / ab)	130°
Angle (up / down)	130°
Biegeradius	8 mm
Bending radius	8 mm
Tiefenschärfe	5-50 mm
Depth of focus	5-50 mm
Gewicht	260 g
Weight	260 g
inkl. Dichtigkeitstester	
incl. leak tester	



Art.-Nr.	Blickfeld	
Art.-No.	Field of vision	
130 400 028ST	100°	2,8 mm / 2.8 mm
130 400 034ST	80°	3,4 mm / 3.4 mm
130 414 040ST	80°	Ø 4 mm mit Arbeitskanal, Ø 1,4 mm Ø 4 mm with working channel, Ø 1.4 mm

Unsere Nasopharyngoskope der neuesten Generation sind intuitiv bedienbar und ergonomisch optimiert. Sie wurden für die notwendige Feinfühligkeit im täglichen Routineeinsatz und für eine ermüdungsfreie Handhabung entwickelt. Hochwertige Bildleiter und ein leistungsfähiges optisches System liefern große und helle Bilder in bester Auflösung - die Voraussetzung für eine sichere Diagnose und Therapie. Dank solider Verarbeitung und konsequenter Verwendung moderner Hochleistungswerkstoffe sind unsere Nasopharyngoskope äußerst robust und langlebig - trotz steigender Belastung durch moderne Aufbereitungsverfahren.

Our newest generation nasopharyngoscopes impresses with intuitive operability and optimal ergonomics, designed for tactile sensation and non-tiring handling as required in daily routine operations.

High-end fibre-optic bundles and a high-capacity system produce large and bright images of the best quality - necessary for safe diagnosis and treatment. Due to the consistent use and reliable processing of high-class materials, our nasopharyngoscopes are robust and durable, in spite of the increasing stress of modern cleaning and sterilizing facilities.

#### Vorteile unserer Endoskope:

- Funktionelles Design für eine einfache und komfortable Handhabung
- Feinfühlig, aber robuste Steuerung
- Optimale Flexibilität und Torsionssteifigkeit des Einführungsschafts
- Leistungsfähiges optisches System: größere, hellere und schärfere Bilder

#### Geeignete Wiederaufbereitungsverfahren:

- Einlegbar in Reinigungs- und Desinfektionslösung
- NTDF-Sterilisation = Niedertemperatur-Dampf-Formaldehyd-Sterilisation
- Maschinelle Aufbereitung (RDG-E)

#### Advantages of our endoscopes:

- Functional design for easy and comfortable handling
- Sensitive yet robust control
- Optimal flexibility and torsional rigidity of the insertion channel
- High-performance optical system for larger, brighter and sharper images

#### Suitable reprocessing procedures:

- Fully immersible in cleaning and disinfectant solutions
- LTSF-sterilization = Low-Temperature Steam and Formaldehyde sterilization
- Machine reprocessing (RDG-E)





**Dichtigkeitstester für flexible Endoskope**  
**Leak tester for flexible endoscopes**

**30-169-08**

**Flexible Biopsiezange, Ø 1 mm, ovaler Löffel,**  
**für flexibles Endoskop 30-171-40**

**Flexible biopsy forceps, Ø 1 mm, oval cups,**  
**for flexible endoscope 30-171-40**



Art.-Nr./No.	Länge / Length (cm)
30-172-40	120

**Flexible Alligator-Fasszange, Ø 1 mm,**  
**gezahntes Maul, für flexibles Endoskop 30-171-40**

**Flexible alligator forceps, Ø 1 mm,**  
**serrated jaws, for flexible endoscope 30-171-40**

Art.-Nr./No.	Länge / Length (cm)
30-173-40	120



**Reinigungsbürste mit Grifföse, AL 40 cm, Bürste Ø 2,0 mm, Besatz-**  
**länge 10 mm, für Arbeitskanal bis 1,5 mm, 10 Stück / Box, Einweg**  
**Cleaning brush with loop, WL 40 cm, brush Ø 2.0 mm, length of**  
**edging 10 mm, for working channels up to 1.5 mm, 10 pieces/ box,**  
**single use**

**30-175-40**



**MATRIX LED duo 2,**  
**LED Hochleistungslichtquelle, 2 Lichtauslässe, 100-240 V**

**MATRIX LED duo 2,**  
**LED high-performance light source, 2 light outputs, 100-240 V**

**70-203-00**



**Hochleistungs-Fiberglas-Lichtleitkabel,**  
**Ø 3,5 mm, 3000 mm, Endoskopseitig 90° abgewinkelt,**  
**Storz/Storz Anschlüsse, autoklavierbar**

**High definition fibre light cable, Ø 3.5 mm, 3000 mm,**  
**90° endoscope side angled, Storz/Storz connector,**  
**autoclavable**

**70-267-03**

## 02 Endoskopie und Videodokumentation

### Endoscopy and Video Documentation



**Hochleistungs-Fiberglas-Lichtleitkabel,  
SPIGGLE & THEIS-Anschlüsse, autoklavierbar**  
High definition fibre light cable,  
SPIGGLE & THEIS connection, autoclavable

Art.-Nr./No.	AD / OD (mm)	Länge / Length (cm)
70-258-35	3,5	180
70-258-48	4,8	180
70-259-35	3,5	230
70-259-48	4,8	230
70-260-35	3,5	300
70-260-48	4,8	300



**Hochleistungs-Fiberglas-Lichtleitkabel,  
Ø 3,5 mm, 1800 mm, 90° abgewinkelt, autoklavierbar**  
High definition fibre light cable,  
Ø 3.5 mm, 1800 mm, 90° angled, autoclavable

Art.-Nr./No.	Beschreibung / Description
70-265-01	Wolf/Wolf-Adapter / connector Geräteseitig abgewinkelt / lightsource side angled
70-265-02	Storz/Storz-Adapter / connector Geräteseitig abgewinkelt / lightsource side angled
70-266-02	Storz/Storz-Adapter / connector Endoskopseitig abgewinkelt / endoscope side angled



**Desinfektionssystem für starre und flexible Endoskope,  
720 x 120 x 60-120 mm**  
Disinfection system for rigid and flexible endoscopes,  
720 x 120 x 60-120 mm

**70-470-00**



**Desinfektions-Wandhalterung für flexible Endoskope,  
4 Glasköcher, Aufhängung höhenverstellbar, Timer,  
233 x 750 x 60 mm (Lieferung ohne Endoskop)**  
Disinfection wall holder, for flexible endoscopes,  
4 glass tubes, hanging height adjustable, timer,  
233 x 750 x 60 mm (Delivery without endoscope)

**70-472-00**

**Weitere Lichtleitkabel und Adapter auf Anfrage**  
**More light cables and connectors on request**



## 03 Septum-Instrumente

### Septum Instruments



**Killian-Struycken Septumspeculum, 13,5 cm**  
**Killian-Struycken septum speculum, 13.5 cm**

Art.-Nr./No.	Größe / Size (cm)
20-150-40	40
20-150-55	55
20-150-65	65
20-150-75	75
20-150-90	90

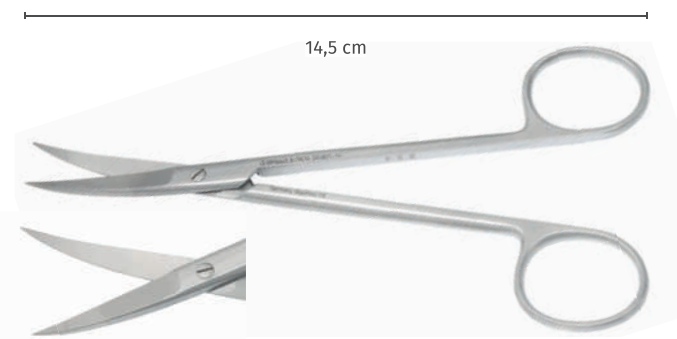

**Joseph Schere, spitz-spitz, gebogen 14,5 cm**  
**Joseph scissors, pointed, curved, 14.5 cm**

**20-601-14**

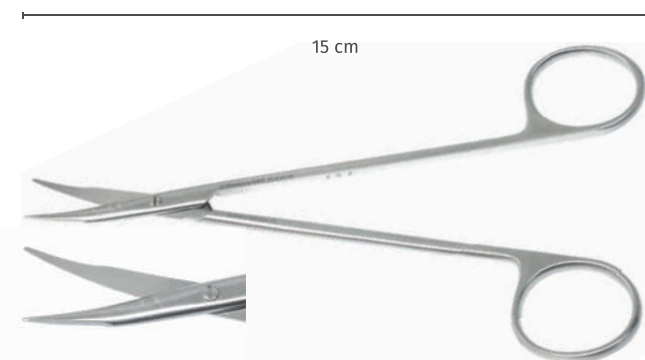

**Reynolds Schere, stumpf-stumpf, gebogen, verjüngte Spitzen, 15 cm**  
**Reynolds scissors, blunt-blunt, curved, tapered tips, 15 cm**

**20-610-15**



**Walter Schere, abgewinkelt, 10 cm**  
**Walter scissors, angled, 10 cm**

**20-630-10**



## 03 Septum-Instrumente

### Septum Instruments



**Joseph Schere, Premium Line, spitz-spitz**  
Joseph Scissor, premium scissor, pointed

Premium Line

Art.-Nr.	Länge (cm)	Beschreibung
20-640-14	14,5	gerade
20-641-14	14,5	gebogen



**Reynolds Schere, Premium Line,**  
**stumpf-stumpf, gebogen, verjüngte Spitzen**  
Reynolds scissors, premium line,  
blunt-blunt, curved, tapered tips

Premium Line

Art.-Nr.	Länge (cm)
20-635-15	15,0
20-635-18	18,0



## 03 Septum-Instrumente

### Septum Instruments

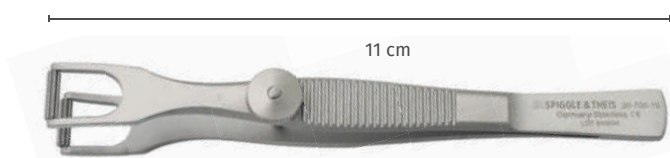

**Cottle Columella-Klemme, 11 cm / Cottle columella forceps, 11 cm**

**20-700-10**



**Adson-Brown Pinzette, 7:8 Zähne, 12,5 cm**

**Adson-Brown forceps, 7:8 teeth, 12.5 cm**

**20-710-12**

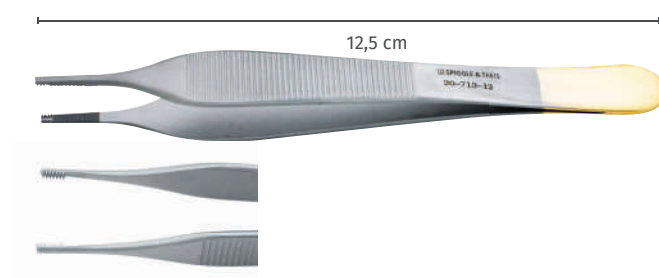

**Adson-Brown Pinzette, Hartmetall, 7:8 Zähne, 12,5 cm**

**Adson-Brown forceps, carbide, 7:8 teeth, 12.5 cm**

**20-713-12**

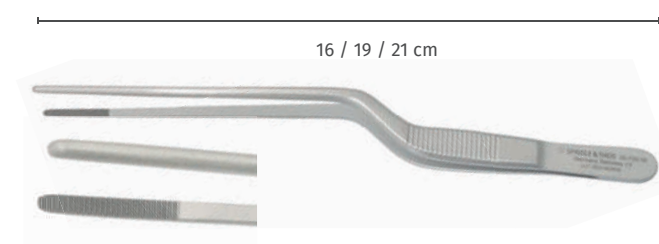

**Jansen Nasenpinzette, bajonett, anatomisch**

**Jansen nasal forceps, bayonet, anatomical**

Art.-Nr./No.	Länge / length (cm)	Beschreibung / Description
20-730-16	16	
20-730-19	19	
20-730-21	21	
20-731-16	16	1:2 Zähne/1:2 teeth

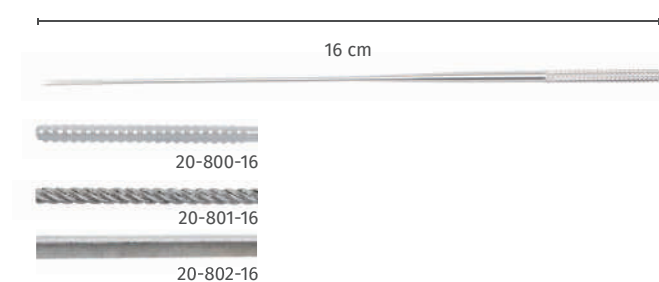

**Watteträger, Ø 1,2 mm, 16 cm, 5 Stück**

**Cotton carrier, Ø 1.2 mm, 16 cm, 5 pieces**

Art.-Nr./No.	Beschreibung / Description
20-800-16	dreikant, gerieft / triangle, serrated
20-801-16	rund, gerieft / round, serrated
20-802-16	dreikant, glatt / triangular, smooth

## 03 Septum-Instrumente

### Septum Instruments



**Cottle Septum-Messer, 14 cm / Cottle septum knife, 14 cm**

**20-500-13**

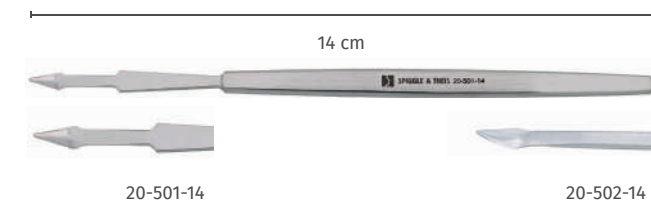

**Masing Ritzmesser, 14 cm / Masing pointed knife, 14 cm**

Art.-Nr./No.	Beschreibung / Description
20-501-14	mit Kerbe / grooved
20-502-14	glatt / smooth



**Masing Elevatorium/Raspatorium, 21 cm**

**Masing elevator/raspatory, 21 cm**

**20-300-21**

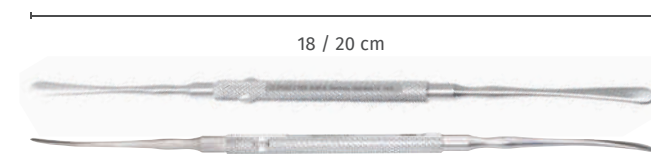

**Freer Doppelelevatorium, scharf-stumpf**

**Freer elevator, double ended, sharp-blunt**

Art.-Nr./No.	Länge / length (cm)
20-305-18	18
20-306-20	20



**Weber Doppelelevatorium, scharf/stumpf, 18,5 cm**

**Weber elevator, double ended, sharp/blunt, 18.5 cm**

**20-307-18**

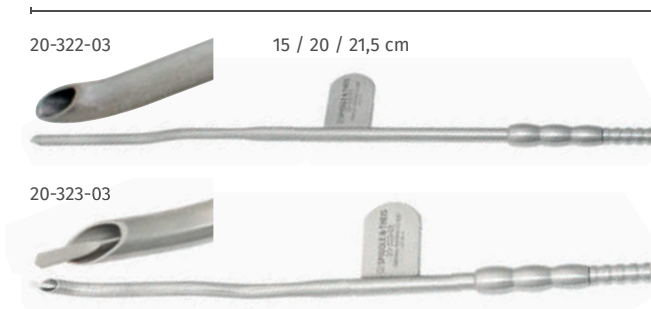

**Guillen Saugraspatorium, 4,5 mm**

**Guillen suction raspatory, 4.5 mm**

Art.-Nr./No.	Beschreibung / Description
20-322-01	20 cm, gerade / straight
20-322-02	20 cm, links gebogen / curved left
20-322-03	21,5 cm, rechts gebogen / curved right
20-323-01	15 cm, gerade / straight
20-323-02	15 cm, links gebogen / curved left
20-323-03	15 cm, rechts gebogen / curved right



## 03 Septum-Instrumente

### Septum Instruments



**Cottle Hammer, 18 cm**

**Cottle mallet, 18 cm**

**20-400-18**

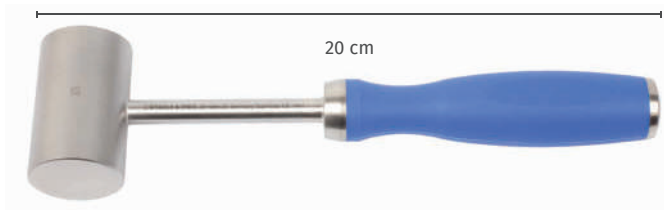

**Hammer, mit Silikongriff, 20 cm**

**Mallet, with silicone handle, 20 cm**

**20-404-20**



**Cottle Meißel, flach, 18,5 cm / Cottle chisel, flat, 18.5 cm**

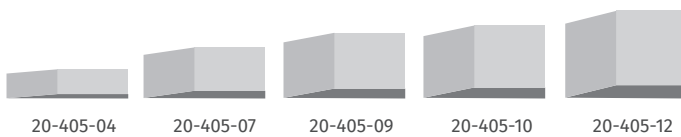

Art.-Nr./No.	Größe / Size (mm)
20-405-04	4,0
20-405-07	7,0
20-405-09	9,0
20-405-10	10,0
20-405-12	12,0

## 03 Septum-Instrumente

### Septum Instruments

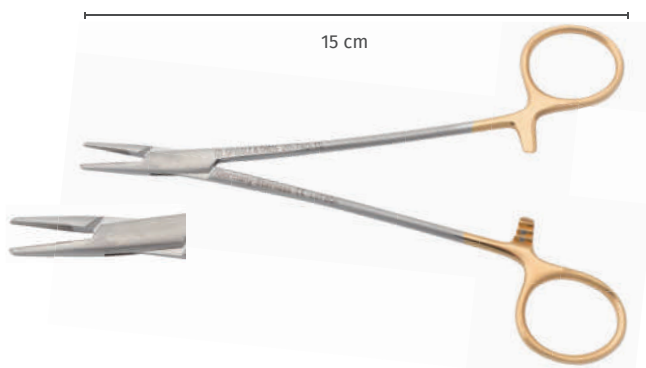

**Crile-Wood Nadelhalter, Hartmetall, 15 cm**  
Crile-Wood needleholder, tungsten carbide, 15 cm

20-740-15

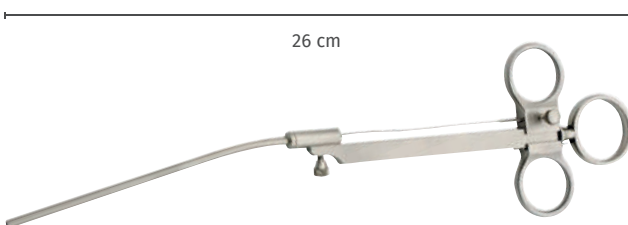

**Krause Nasen-Polypen-Schnürer, scharf, 26 cm**  
Krause nasal polyp snare, sharp, 26 cm

20-190-25



**Nasenpolypenschlingen, 0,35 mm, 10 cm, 100 Stück**  
Nasal polyp snare wires, 0.35 mm, 10 cm, 100 pieces

20-195-35

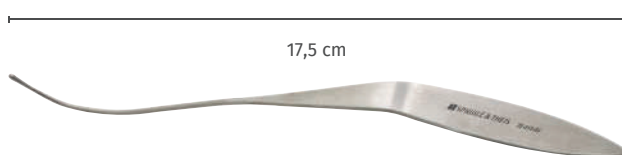

**Nasensonde, s-förmig gebogen, biegsam, 17,5 cm**  
Nasal probe, s-shaped, bendable, 17.5 cm

20-313-00



**Cottle Nasenflügelhaken, 14 cm / Cottle alar retractor, 14 cm**

20-560-14





## 03 Septum-Instrumente

### Septum Instruments



**Bipolare Pinzette, NON-STICK, bajonett, Spitze 0,5 mm, 16 cm**  
**Bipolar forceps, NON-STICK, bayonet, tip 0.5 mm, 16 cm**

**80-110-16**



**Bipolare Pinzette, NON-STICK, bajonett, Spitze 0,7 mm, 23 cm**  
**Bipolar forceps, NON-STICK, bayonet, tip 0.7 mm, 23 cm**

**80-126-23**



**Geräteseitig, 22 mm, passend für / unit-side, 22 mm, compatible to Erbe / EMC / Dolly**

Art.-Nr./No.	Länge / Length (m)
80-316-50	5



**Geräteseitig, passend für / unit-side, compatible to Sutter/Martin/Berchtold/Aesculap/Integra/SPIGGLE & THEIS**

Art.-Nr./No.	Länge / Length (m)
80-317-30	3
80-317-50	5



**Geräteseitig, 29 mm, passend für / unit-side, 29 mm, compatible to Valleylab/Lamidey/EMC/Bowa/Olympus**

Art.-Nr./No.	Länge / Length (m)
80-319-30	3
80-319-50	5

\* Abbildungen der Kabel sind ähnlich / images similar to product

### 03 Septum-Instrumente Blakesley Komfort Serie Nasenzange

#### Septum Instruments Blakesley Comfort Series nasal forceps

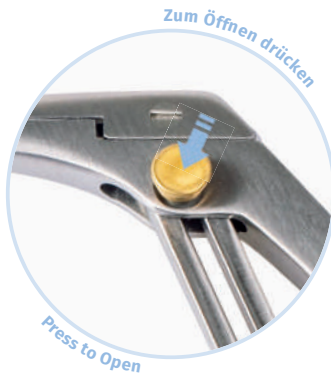

**Blakesley Nasenzange, komfort, durchschneidend, Druckknopf vergoldet**  
**Blakesley nasal forceps, comfort, throughcutting, golden button**

Art.-Nr. Art.-No.	Länge Length (cm)	Größe Size (mm)	Winkel Angle
20-915-00	12	3,0	gerade / straight
20-915-01	12	3,5	gerade / straight
20-915-02	12	4,0	gerade / straight
20-915-03	12	5,0	gerade / straight
20-915-04	12	6,0	gerade / straight
20-915-10	15	3,0	gerade / straight
20-915-12	15	4,0	gerade / straight
20-925-00	12	3,0	45° aufgebogen / 45° curved upwards
20-925-01	12	3,5	45° aufgebogen / 45° curved upwards
20-925-02	12	4,0	45° aufgebogen / 45° curved upwards
20-925-03	12	5,0	45° aufgebogen / 45° curved upwards
20-925-04	12	6,0	45° aufgebogen / 45° curved upwards
20-935-01	12	3,5	90° aufgebogen / 90° curved upwards
20-935-02	12	4,0	90° aufgebogen / 90° curved upwards
30-943-01	12	1,9 x 5,0	gerade / straight
30-943-02	12	2,5 x 6,0	gerade / straight
30-943-03	12	3,0 x 7,0	gerade / straight
30-943-04	12	3,8 x 10	gerade / straight
30-943-11	12	1,9 x 5,0	45° aufgebogen / 45° curved upwards
30-943-12	12	2,5 x 6,0	45° aufgebogen / 45° curved upwards
30-943-13	12	3,0 x 7,0	45° aufgebogen / 45° curved upwards

#### Vorteile

- Schnelle und einfache Öffnung des Schiebeschafts
- Validierte Reinigung
- Sichere Lagerung in der Abwurfsiebschale
- Höhere Standzeit

#### Advantages

- Quick and easy opening of the sliding shaft
- Guaranteed cleaning
- Safe and comfortable storage
- Made to last



### 03 Septum-Instrumente Blakesley Nasenzange Premium Modell

#### Septum Instruments Blakesley premium model nasal forceps



#### gerade / straight

Art.-Nr. Art.-No.	Größe Size (mm)		Länge Length (cm)
20-215-00	3,0		11,5
20-215-01	3,5		11,5
20-215-02	4,0		11,5
20-215-03	5,0		11,5
20-215-04	6,0		11,5
20-215-10	3,0		15,0
20-215-12	4,0		15,0
20-215-14	6,0		15,0



#### 45° aufgebogen, 11,5 cm / curved upwards 45°, 11.5 cm

Art.-Nr./No.	Größe / Size (mm)	
20-225-00	3,0	
20-225-01	3,5	
20-225-02	4,0	
20-225-03	5,0	
20-225-04	6,0	

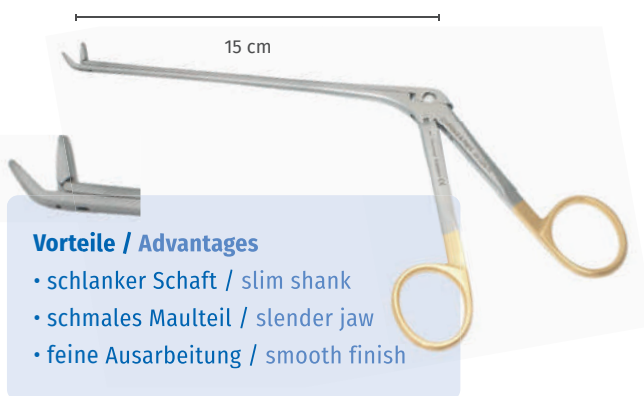

#### 90° aufgebogen, 11,5 cm / curved upwards 90°, 11.5 cm

Art.-Nr./No.	Größe / Size (mm)	
20-235-01	3,5	
20-235-02	4,0	
20-235-03	5,0	



#### 45° aufgebogen, 15 cm / curved upwards 45°, 15 cm

Art.-Nr./No.	Größe / Size (mm)	
20-225-11	3,5	
20-225-12	4,5	
20-225-14	6,0	



**Hartmann Nasentamponadezange**

**Hartmann nasal dressing forceps**

Art.-Nr./No.	Größe / Size (cm)	
20-200-16	16	fein / delicate
20-200-20	20	



**Wigand Polypen-Fasszange, 60° aufgebogen, 11,5 cm**

**Wigand polyp-grasping forceps, 60° angled, 11.5 cm**

**20-236-00**



**Strümpel-Voss Nasenzange, 45°, 11,5 cm**

**Strümpel-Voss nasal forceps, 45°, 11.5 cm**

**20-238-00**

## 03 Septum-Instrumente

### Septum Instruments

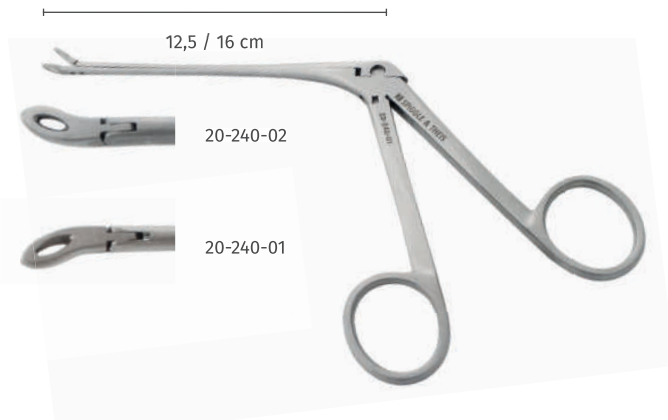

#### Blakesley Nasenzange / Blakesley nasal forceps

Art.-Nr./No.	Größe / Size (cm)	Winkel / Angle
20-240-01	12,5	links gebogen / curved left
20-240-02	12,5	rechts gebogen / curved right
20-240-11	16,0	links gebogen / curved left
20-240-12	16,0	rechts gebogen / curved right



#### Takahashi Nasenzange / Takahashi nasal forceps

Art.-Nr. Art.-No.	Länge Length (cm)	Größe Size (mm)	Winkel Angle
20-245-01	11,5	2,5	gerade / straight
20-245-02	11,5	2,5	30° aufgebogen 30° curved upwards
20-245-11	15,0	2,5	gerade / straight
20-245-12	15,0	2,5	30° aufgebogen 30° curved upwards
20-246-01	11,5	4,0	gerade / straight
20-246-02	11,5	4,0	30° aufgebogen 30° curved upwards



#### Takahashi Nasenzange, komfort, Druckknopf vergoldet, 12 cm

#### Takahashi nasal forceps, comfort, golden button, 12 cm

Art.-Nr./No.	Größe / Size (mm)	Winkel / Angle
20-945-01	2,5	gerade / straight
20-945-02	2,5	45° aufgebogen 45° curved upwards
20-946-01	4,0	gerade / straight
20-946-02	4,0	45° aufgebogen 45° curved upwards

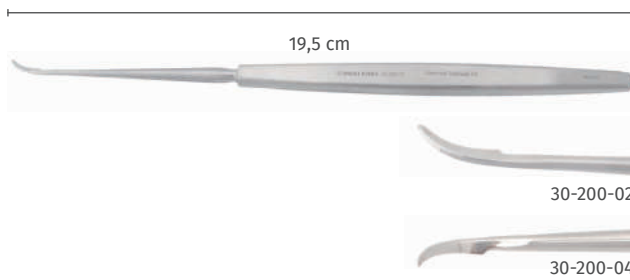

**Sichelmesser, gerader Schaft, 19,5 cm**

**Sickle knife, straight shaft, 19.5 cm**

Art.-Nr./No.	Beschreibung / Description
30-200-01	spitz / pointed
30-200-02	abgerundet / rounded
30-200-03	links gebogen, spitz curved left, pointed
30-200-04	rechts gebogen, spitz curved right, pointed

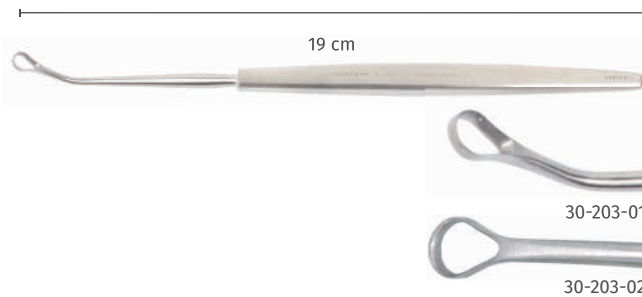

**Antrum-Kürette, gerader Schaft, 19 cm**

**Antrum curette, straight shaft, 19 cm**

Art.-Nr./No.	Beschreibung / Description
30-203-01	vorwärts schneidend / forward cutting
30-203-02	rückwärts schneidend / backward cutting



**Antrum-Löffel, oval, 7,0 x 10,5 mm, gebogen, 19,5 cm**

**Antrum curette, oval, 7.0 x 10.5 mm, curved, 19.5 cm**

**30-205-01**



**Antrum-Löffel, längsoval, 45° gewinkelt, 19,5 cm**

**Antrum curette, oval, 45° angled, 19.5 cm**

Art.-Nr./No.	Beschreibung / Description
30-205-02	klein (2,5 x 6,0 mm) / small
30-205-03	groß (4,0 x 9,0 mm) / large





## 04 FESS-Instrumentarium

### FESS Instruments



**Stirnhöhlen-Löffel, gerader Schaft, längsoval, Löffelgröße 2,5 x 6,0 mm, 19 cm**  
**Frontal sinus curette, straight shaft, oval, tip size 2.5 x 6.0 mm, 19 cm**

Art.-Nr./No.	Winkel / Angle
30-205-04	55° aufgebogen / 55° curved upwards
30-205-06	90° aufgebogen / 90° curved upwards
30-205-70	70° aufgebogen / 70° curved upwards



**Wigand Stirnhöhlenraspel, 21 cm**  
**Wigand frontal sinus rasp, 21 cm**

**30-209-01**

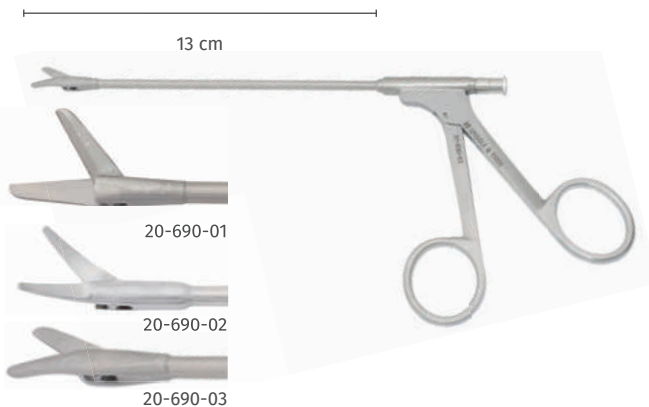

**Conchotomie Schere, gezahnt, Rohrschaft, mit Spülkanal, 13 cm**  
**Nasal conchotomy scissors, serrated, tubular model, with irrigation channel, 13 cm**

Art.-Nr./No.	Beschreibung / Description
20-690-01	gerade / straight
20-690-02	links gebogen / curved left
20-690-03	rechts gebogen / curved right



**Weber Nasenschere, extra fein, gerade, mit Spülkanal, 10,5 cm**  
**Weber nasal scissors, very fine, straight, with irrigation channel, 10.5 cm**

**20-691-01**



Diese Scheren eignen sich hervorragend zur Eröffnung von Siebbeinzellen unter weitgehender Erhaltung der Schleimhaut.

Ein „Anstechen“ und nicht „Vorschieben“ der Siebbeinschleimhaut ist mit der extra feinen und verlängerten unteren Schneide gewährleistet.

Dr. med. Hohenhorst,  
Chefarzt der HNO Abteilung des  
Alfried Krupp Krankenhauses in Essen

These scissors are ideally suited for opening ethmoidal cells while keeping the mucous membrane largely intact.

The super-fine and elongated lower blade ensures that the mucous membrane of the ethmoid bone is “punctured” and not “pushed forward.”

Dr. med. Hohenhorst,  
Chief physician of the ENT department  
of the Alfred Krupp Clinic, Essen, Germany



**Conchotomie Schere, 11,5 cm**

**Nasal conchotomy scissors, 11.5 cm**

Art.-Nr./No.	Beschreibung / Description
20-693-00	standard / standard
20-693-01	extra fein / extra delicate
20-693-02	extra fein, spitz, untere Schneide verlängert extra delicate, pointed, lower blade longer



**Stirnhöhle sonde, doppelseitig, leicht gebogen, 20,5 cm**

**Frontal sinus probe, double ended, slightly curved, 20.5 cm**

**30-207-01**



**Kieferhöhlen sonde, doppelseitig, 19 cm**

**Maxillary sinus probe, double ended, 19 cm**

**30-207-02**

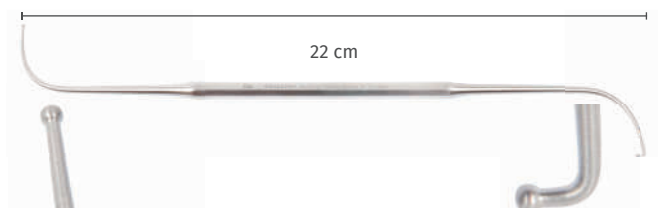

**Stirnhöhle sonde, doppelseitig, stark gebogen, 22 cm**

**Frontal sinus probe, double ended, strongly curved, 22 cm**

**30-207-03**



## 04 FESS-Instrumentarium

### FESS Instruments

SPIGGLE & THEIS Medizintechnik GmbH legt besonderen Wert darauf, dass alle Instrumente und Endoskope nach validierten Verfahren aufbereitet werden können. Dies bezieht sich sowohl auf die Reinigung als auch auf die Sterilisation der Produkte. Innovative Lösungen wie Spülkanäle in Rohrschaft-Instrumenten oder Zerlegbarkeit von Zangen und Stanzen belegen unsere Vorreiterrolle in diesem Bereich.

It is of special importance to SPIGGLE & THEIS Medizintechnik GmbH that all our instruments and endoscopes can be processed in accordance with accepted validation methods, regarding both the cleaning and the sterilization of the products. Our pioneering position in this field is supported by such innovative solutions as irrigation channels in tube-shaft instruments as well as detachable slide-bar instruments for forceps and punches.

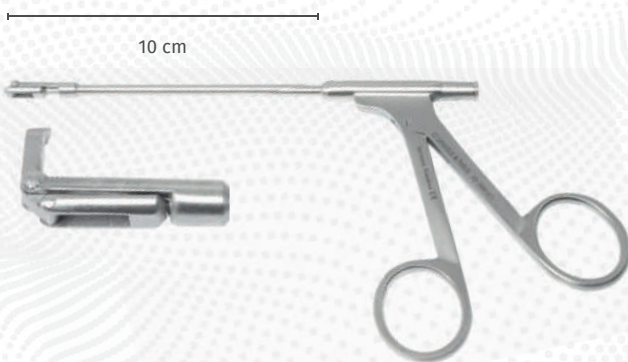

#### **Antrumstanze, rückwärts schneidend, 2,5 mm, mit Spülkanal, 10 cm**

**Antrum punch, backward cutting, 2.5 mm, with irrigation channel, 10 cm**

Art.-Nr./No.	Beschreibung / Description
30-300-01	Gerade schneidend / straight cutting
30-300-02	Links schneidend / left cutting
30-300-03	Rechts schneidend / right cutting



#### **Antrumstanze, rückwärts schneidend, gerade, 1,5 mm, 10 cm, mit Spülkanal**

**Antrum punch, backward cutting, straight, 1.5 mm, 10 cm, with irrigation channel**

Art.-Nr./No.	Beschreibung / Description
30-302-01	Gerade schneidend / straight cutting
30-302-02	Links schneidend / left cutting
30-302-03	Rechts schneidend / right cutting

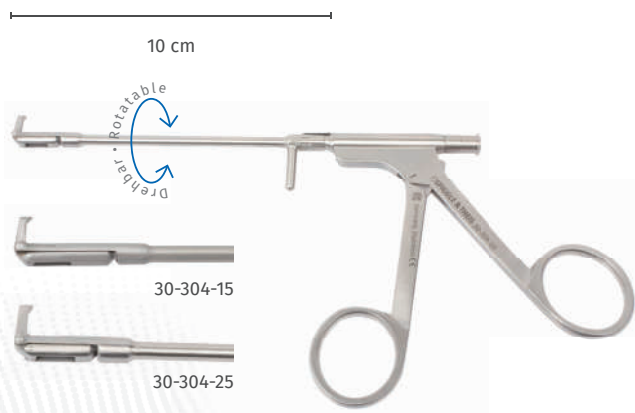

**Antrumstanze, rückwärts schneidend, drehbar, 2,5 mm, mit Spülkanal, 10 cm**  
**Antrum punch, backward cutting, rotatable, 2.5 mm, with irrigation channel, 10 cm**

Art.-Nr./No.	Größe / Size (mm)
30-304-15	1,5
30-304-25	2,5

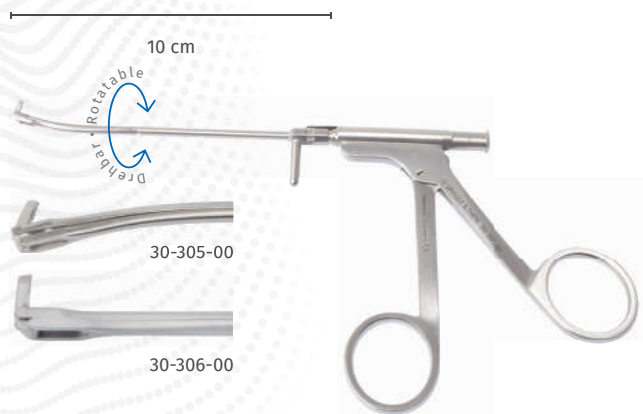

**Tobey Mikro-Antrumstanze, rückwärts schneidend, drehbar, mit Spülkanal, 10 cm**  
**Tobey micro antrum punch, backward cutting, rotatable, with irrigation channel, 10 cm**

Art.-Nr./No.	Beschreibung / Description
30-305-00	Schaft abwärts gebogen / downwards curved shaft
30-306-00	gerader Schaft / straight shaft
30-307-00	Schaft aufwärts gebogen / upwards curved shaft

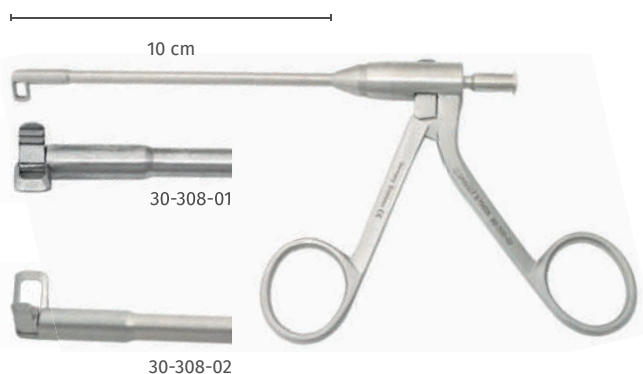

**Antrumstanze, seitwärts schneidend, 10 cm**  
**Antrum punch, sideways cutting, 10 cm**

Art.-Nr./No.	Beschreibung / Description
30-308-01	Links schneidend / left cutting
30-308-02	Rechts schneidend / right cutting



## 04 FESS-Instrumentarium

### FESS Instruments

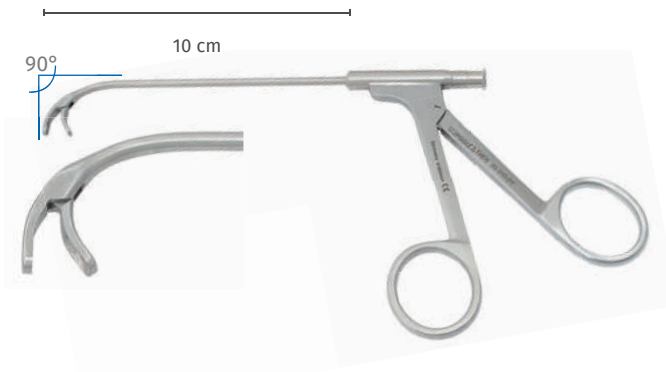

**Kieferhöhlen Polypen-Fasszange, rückwärts öffnend, mit Spülkanal, 10 cm**  
**Antrum polyp grasping forceps, retrograde opening, with irrigation channel, 10 cm**

**30-310-01**

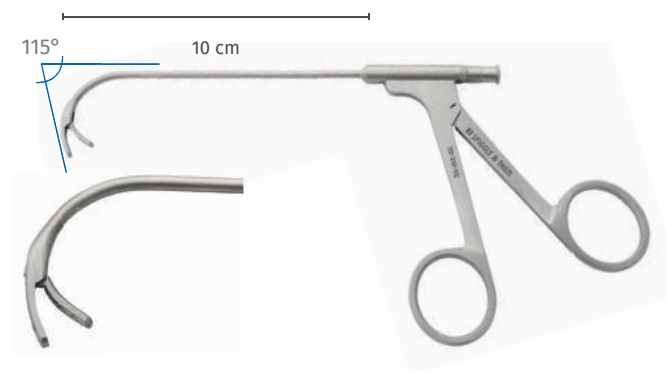

**Kieferhöhlen Polypen-Fasszange, rückwärts öffnend, extra langer Schaftbogen, mit Spülkanal, 10 cm**  
**Antrum polyp grasping forceps, retrograde opening, extra long shaft curve, with irrigation channel, 10 cm**

**30-310-02**

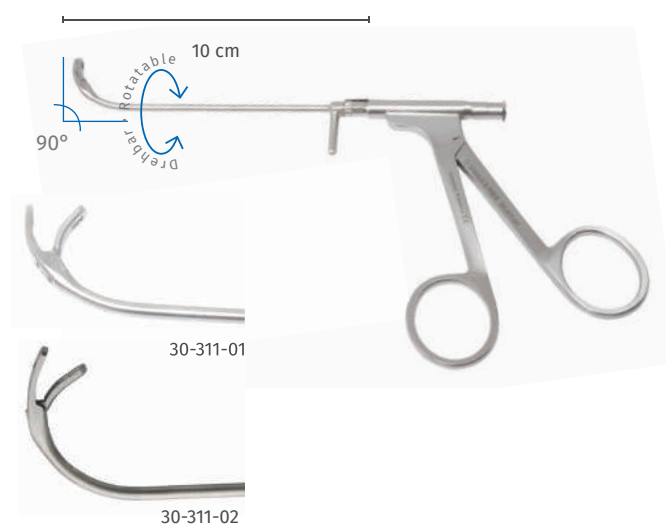







**Kieferhöhlen Polypen-Fasszange, rückwärts öffnend, drehbar, 10 cm**  
**Antrum polyp grasping forceps, retrograde opening, rotatable, 10 cm**

Art.-Nr./No.	Beschreibung / Description
30-311-01	normaler Schaft / normal shaft
30-311-02	extra langer Schaftbogen / extra long shaft curve



**Durchschneidende Nasenzange / Throughcutting nasal forceps**

Art.-Nr. Art.-No.	Größe Size (mm)	Länge Length (cm)		Winkel Angle
30-320-01	5,0 x 1,5	14,0		gerade / straight
30-320-02	6,5 x 2,5	11,5		gerade / straight
30-321-01	5,0 x 1,5	14,0		45° gewinkelt / 45° angled
30-321-02	6,5 x 2,5	11,5		60° gewinkelt / 60° angled
30-322-01	5,0 x 1,5	14,0		aufgebogen / curved upwards
30-322-02	8,0 x 3,0	14,0		aufgebogen / curved upwards

**Vorteile / Advantages**

Stumpfes Ende = Dura-Schutz  
Blunt end = dura protection

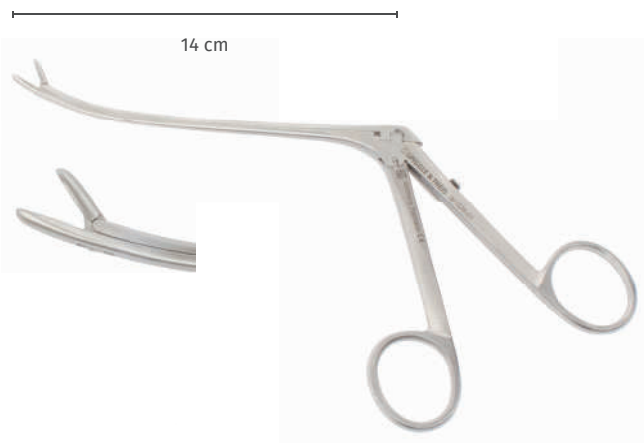

**Löffelzange, aufgebogen, kräftig, 6,5 x 2,5 mm, 14 cm**  
**Cup Forceps, curved upwards, robust, 6.5 x 2.5 mm, 14 cm**

**30-328-01**





## 04 FESS-Instrumentarium

### FESS Instruments

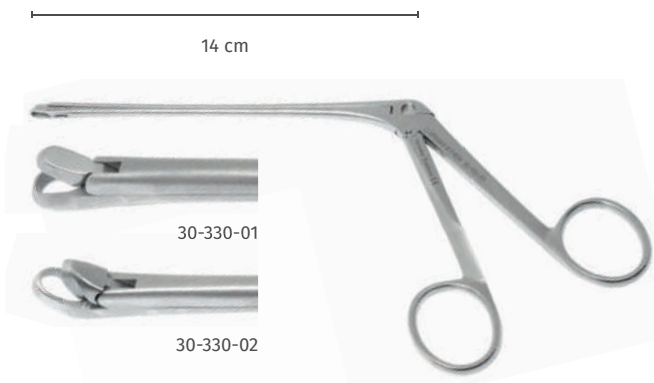

**Wigand durchschneidende Zange, flach, abgerundet, 14 cm**  
**Wigand throughcutting forceps, flat, rounded, 14 cm**

Art.-Nr. Art.-No.	Größe Size (mm)	Winkel Angle
30-330-01	4,0 x 3,0	gerade / straight
30-330-02	4,0 x 3,0	45° aufgewinkelt / 45° angled



**Herberhold cranial durchschneidende Zange, flach**  
**Herberhold cranial throughcutting forceps, flat**

Art.-Nr. Art.-No.	Größe Size (mm)	Länge Length (cm)	Winkel Angle
30-332-01	6,0 x 2,0	14	gerade / straight
30-332-02	11,5 x 2,5	14	gerade / straight
30-333-01	6,0 x 2,0	14	60° aufgebogen 60° curved upwards
30-333-02	11,5 x 2,5	14	60° aufgebogen 60° curved upwards

#### Vorteile:

- Stanzmaterial wird nach oben ausgeworfen
- Unterer Block (feststehend) kann als Trokar verwendet werden
- Zahnung verhindert Wegrutschen

#### Advantages:

- punched material is ejected upwards
- Lower block (fixed) can be used as trocar
- Serration prevents slipping

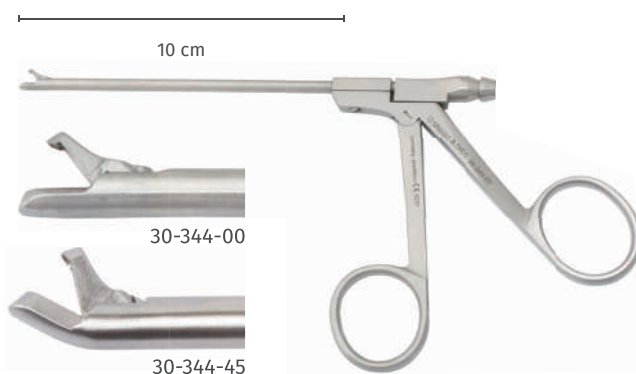

**Durchschneidende Saugzange, 10 cm**  
**Throughcutting suction forceps, 10 cm**

Art.-Nr./No.	Winkel / Angle
30-344-00	gerade / straight
30-344-45	30° aufgewinkelt / 30° angled



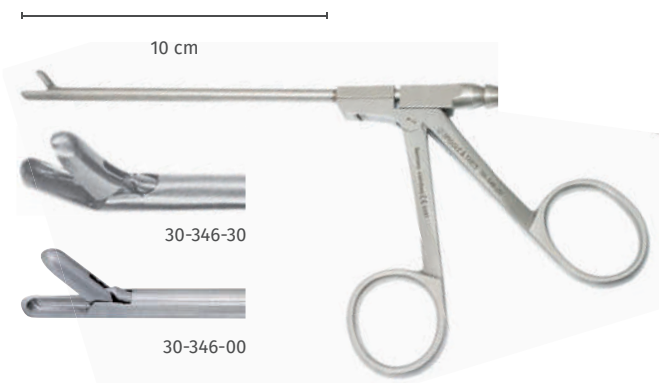

**Takahashi Nasenzange mit Saugkanal, 10 cm**  
**Takahashi suction forceps with suction tube, 10 cm**

Art.-Nr./No.	Winkel / Angle
30-346-00	gerade / straight
30-346-30	30° aufgewinkelt / 30° angled

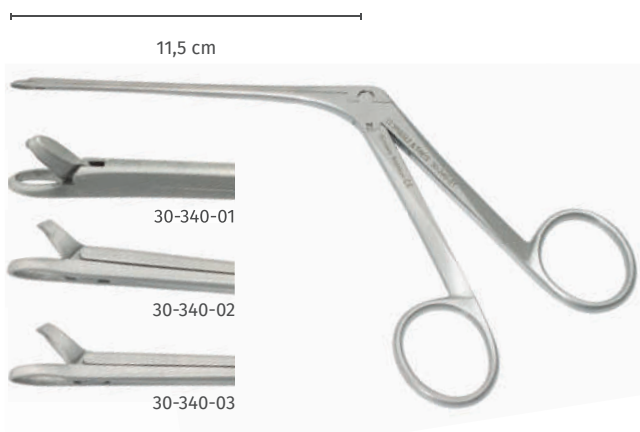

**Blakesley Nasenzange, durchschneidend, gerade, 11,5 cm**  
**Blakesley nasal forceps, throughcutting, straight, 11.5 cm**

Art.-Nr./No.	Größe / Size (mm)
30-340-01	5,0 x 2,0
30-340-02	6,0 x 2,5
30-340-03	7,0 x 3,0



**Blakesley Nasenzange, durchschneidend, 45° aufgebogen, 11,5 cm**  
**Blakesley nasal forceps, throughcutting, 45° curved upwards, 11.5 cm**

Art.-Nr./No.	Größe / Size (mm)
30-342-01	6,0 x 3,0
30-342-02	6,0 x 2,5
30-342-03	8,0 x 3,0

## 04 FESS-Instrumentarium

### FESS Instruments

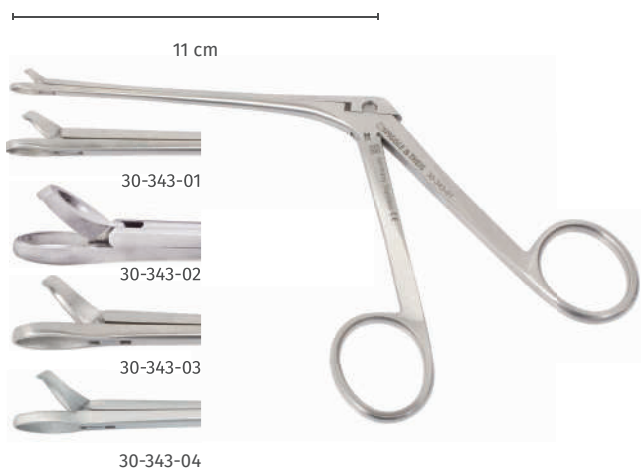

**Blakesley Nasenzange, durchschneidend, gerade, 11 cm**  
**Blakesley nasal forceps, throughcutting, straight, 11 cm**

Art.-Nr./No.	Größe / Size (mm)	Größe / Size
30-343-01	6,0 x 3,0	1
30-343-02	8,0 x 3,5	2
30-343-03	8,0 x 4,0	3
30-343-04	10,0 x 4,8	4

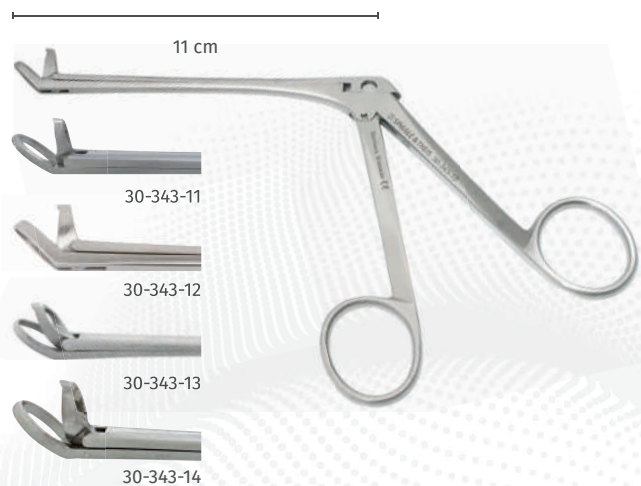

**Blakesley Nasenzange, durchschneidend, 45° aufgebogen, 11 cm**  
**Blakesley nasal forceps, throughcutting, 45° curved upwards, 11 cm**

Art.-Nr./No.	Größe / Size (mm)	Größe / Size
30-343-11	8,0 x 3,0	1
30-343-12	8,0 x 3,5	2
30-343-13	9,0 x 4,2	3
30-343-14	10,0 x 4,8	4

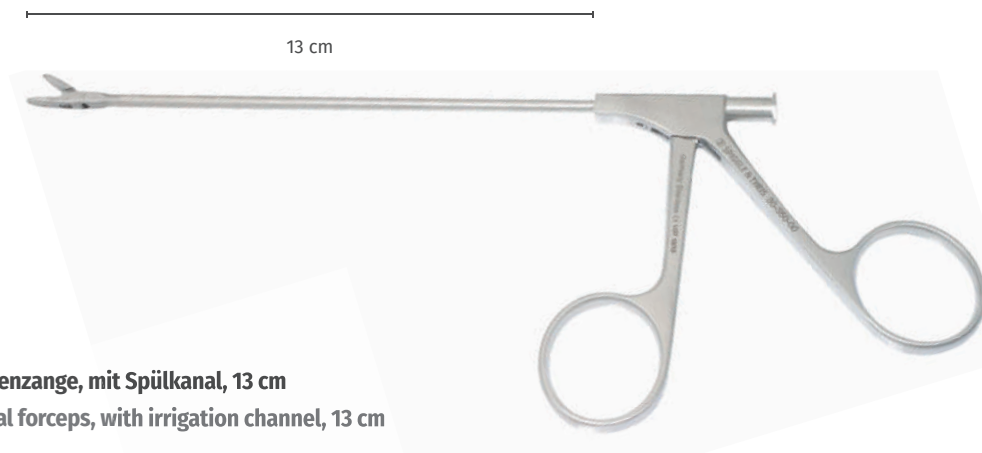
**Blakesley Nasenzange, mit Spülkanal, 13 cm****Blakesley nasal forceps, with irrigation channel, 13 cm**

Art.-Nr./No.	Größe / Size (mm)	Winkel / Angle
30-350-00	3,0	gerade / straight
30-350-01	3,5	gerade / straight
30-350-02	4,0	gerade / straight
30-350-03	5,0	gerade / straight
30-352-00	3,0	45° aufgebogen / 45° curved upwards
30-352-01	3,5	45° aufgebogen / 45° curved upwards
30-352-02	4,0	45° aufgebogen / 45° curved upwards
30-354-01	3,5	90° aufgebogen / 90° curved upwards
30-354-02	4,0	90° aufgebogen / 90° curved upwards
30-358-00	3,0	gerade, durchschneidend / straight, throughcutting
30-358-01	3,5	gerade, durchschneidend / straight, throughcutting
30-358-02	4,0	gerade, durchschneidend / straight, throughcutting
30-360-00	3,0	45° aufgebogen, durchschneidend / 45° curved upwards, throughcutting
30-360-01	3,5	45° aufgebogen, durchschneidend / 45° curved upwards, throughcutting
30-360-02	4,0	45° aufgebogen, durchschneidend / 45° curved upwards, throughcutting

## 04 FESS-Instrumentarium

### FESS Instruments



**Grünwald Rohrschaftzange, durchschneidend, 13 cm, mit Spülkanal**  
**Grünwald tubular forceps, throughcutting, 13 cm, with irrigation channel**

Art.-Nr. Art.-No.	Größe Size (mm)	Winkel Angle
30-370-15	1,5	gerade, Schaft gerade / straight, straight shaft
30-370-20	2,0	gerade, Schaft gerade / straight, straight shaft
30-370-25	2,5	gerade, Schaft gerade / straight, straight shaft
30-370-30	3,0	gerade, Schaft gerade / straight, straight shaft
30-371-15	1,5	45°, Schaft gerade / 45°, straight shaft
30-371-20	2,0	45°, Schaft gerade / 45°, straight shaft
30-371-25	2,5	45°, Schaft gerade / 45°, straight shaft
30-371-30	3,0	45°, Schaft gerade / 45°, straight shaft
30-372-15	1,5	gerade, Schaft 30° aufgebogen / straight, shaft 30° curved upwards
30-372-20	2,0	gerade, Schaft 30° aufgebogen / straight, shaft 30° curved upwards
30-372-25	2,5	gerade, Schaft 30° aufgebogen / straight, shaft 30° curved upwards
30-373-15	1,5	45°, Schaft 30° aufgebogen / 45°, shaft 30° curved upwards
30-373-20	2,0	45°, Schaft 30° aufgebogen / 45°, shaft 30° curved upwards
30-373-25	2,5	45°, Schaft 30° aufgebogen / 45°, shaft 30° curved upwards
30-374-20	2,0	gerade öffnend, Schaft 70° aufgebogen / straight opening, shaft 70° curved upwards
30-375-20	2,0	seitl. rechts öffnend, Schaft 70° aufgebogen / right side opening, shaft 70° curved upwards
30-376-20	2,0	seitl. links öffnend, Schaft 70° aufgebogen / left side opening, shaft 70° curved upwards

## 05 Dieler Bipolare Koagulationszangen

### Dieler bipolar coagulation forceps



Prof. Dr. med. Ralf Dieler  
Leitender Arzt, HNO-Abteilung,  
Rotkreuzklinik Würzburg

Prof. Dr. med. Ralf Dieler  
ENT-specialist  
Rotkreuzklinik Würzburg, Germany

Um den Gewebeschaden durch Koagulation arterieller Blutungen bei chirurgischen Eingriffen in der Nasennebenhöhle (A. ethmoidalis post. oder der A. sphenopalatina) möglichst gering zu halten, sind bipolare Zangen zu bevorzugen. Gegenüber der monopolen Technik wird hierbei bis zu 30% weniger Leistung benötigt. Darüber hinaus entstehen keine relevanten elektrischen Interferenzen mit elektronischen Implantaten (z.B. Herzschrittmacher, Cochlear Implant) oder mit Geräten, die am Patienten angeschlossen sind (z.B. EKG, EEG).

Die Dieler Koagulations-Fasszange ist 30° gewinkelt, gefenestert und 360° drehbar, so dass ein gezieltes Fassen der genannten Gefäße möglich ist. Für eine bessere Sicht im Situs können mit Hilfe eines Einmal-Schlauchsets Blut und Schmauch gleichzeitig abgesaugt werden.

Bipolar forceps should be used in order to minimize tissue damage caused by coagulation in arterial bleeding (post ethmoid artery or the sphenopalatine artery) during paranasal sinus surgery. Up to 30% less power is required in comparison with monopolar technology. A further advantage is that there will be no relevant electrical interference with electrical implants (e.g. cardiac pacemaker, cochlear implant) or bodily function supporting devices (e.g. EKG, EEG).

The Dieler bipolar coagulation forceps is 30° angled, fenestrated and 360° rotatable. This allows a controlled grasping of the mentioned vessels. For better viewing conditions in situs, the disposable attachable suction tube effectively evacuates blood and smoke.

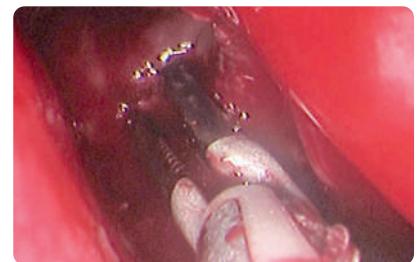

## 05 Dieler Bipolare Koagulationszangen

### Dieler bipolar coagulation forceps

#### Basis-Komponenten / Basic components



**Ringgriff für Dieler Koagulationszange**  
Ring handle for Dieler coagulation forceps

80-090-00



**Schaft für Dieler Koagulationszange, 3 mm, 15 cm**  
Shaft for Dieler coagulation forceps, 3 mm, 15 cm

80-090-01



**Fasszange für Dieler Koagulationszange, 30° gewinkelt, gefenstert, 15 cm**

Grasping forceps for Dieler coagulation forceps, 30° angled, fenestrated, 15 cm

80-090-04





## 05 Dieler Bipolare Koagulationszangen

### Dieler bipolar coagulation forceps

#### Aufsätze / Add-ons



**Fasszange für Dieler Koagulationszange, gerade, gefenstert, 15 cm**  
Grasping forceps for Dieler coagulation forceps, straight, fenestrated, 15 cm

**80-090-03**



**Löffelzange für Dieler Koagulationszange, aufgebogen, 15 cm**  
Spoon forceps for Dieler coagulation forceps, upcurved, 15 cm

Art.-Nr./No.	Größe / Size (mm)
80-090-05	2,0
80-090-06	2,7



**Zange für Dieler Koagulationszange, gerieft, 15 cm**  
Forceps for Dieler coagulation forceps, serrated, 15 cm

Art.-Nr.	Beschreibung / Description
80-090-07	aufgebogen/upcurved
80-090-08	aufgewinkelt/upangled

**Flamingo-Zange für Dieler Koagulationszange, vertikal, 15 cm**  
Flamingo forceps for Dieler coagulation forceps, vertical, 15 cm



Art.-Nr./No.	Winkel / Angle	Länge / Length (mm)
80-090-09	15°	0,7
80-090-10	15°	1,2
80-090-11	15°	2,0
80-090-12	30°	0,7
80-090-13	30°	1,2
80-090-14	30°	2,0
80-090-15	45°	0,7
80-090-16	45°	1,2
80-090-17	45°	2,0



## 05 Dieler Bipolare Koagulationszangen

### Dieler bipolar coagulation forceps



Saugschlauch, steril, 10 Stück/Box  
Suction tube, sterile, 10 pieces/box

80-090-02



Bipolares Anschlusskabel, für Scheren/Zangen,  
3 m lang, geräteseitig, passend für:

Bipolar connecting cable for scissors/forceps,  
3 m, unit-side, compatible with:

Sutter/Martin/ Berchtold/Aesculap/Integra

80-320-30



Bipolares Anschlusskabel, für Scheren/Zangen,  
3 m lang, geräteseitig, passend für:

Bipolar connecting cable for scissors/forceps,  
3 m, unit-side, compatible with:

Valleylab

80-321-30



Bipolares Anschlusskabel, für Scheren/Zangen,  
3 m lang, geräteseitig, passend für:

Bipolar connecting cable for scissors/forceps,  
3 m, unit-side, compatible with:

Erbe/Storz/Wolf

80-322-30



Bipolares Anschlusskabel für Scheren/Zangen,  
4 m lang, passend für:

Bipolar connecting cable for scissors/forceps,  
4 m, compatible with:

U20

80-324-40

## 06 Stirnhöhlen- und Keilbeinhöhlen-Instrumente

### Frontal and Sphenoidal Instruments



**Stirnhöhlenstanze, 70° aufgebogen, 17 cm**

Frontal sinus punch, 70° curved upwards, 17 cm

Art.-Nr./No.	Größe / Size (mm)
30-400-00	3
30-400-01	2



**Rundkopfstanze für Stirnhöhle, mit Spülkanal, 16 cm**

Frontal sinus circular punch, with irrigation channel, 16 cm

Art.-Nr./No.	Größe / Size (mm)	Winkel / Angle
30-421-35	3,5	60°
30-421-45	4,5	60°



**Rundkopfstanze für Stirnhöhle,**

**eiförmig, 90° Schnitt, mit Spülkanal, 16 cm**

Frontal sinus circular punch, egg-form,  
90° cutting, with irrigation channel, 16 cm

Art.-Nr./No.	Größe / Size (mm)	Winkel / Angle
30-428-35	3,5	60°
30-428-45	4,5	60°



## 06 Stirnhöhlen- und Keilbeinhöhlen-Instrumente

### Frontal and Sphenoidal Instruments

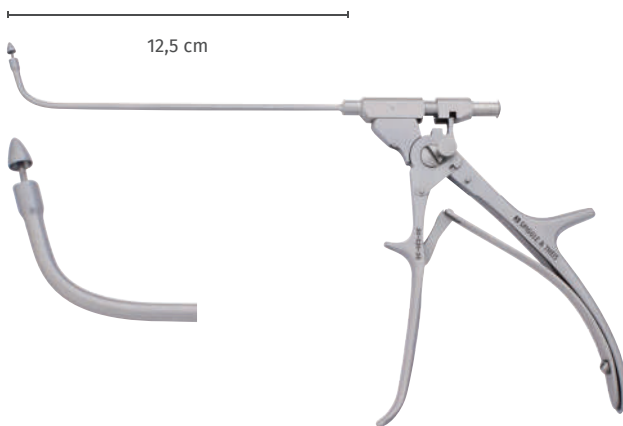

**Stirnhöhlen-Stanze, aufgebogen,  
stumpfes Ende, mit Spülkanal, 12,5 cm**  
Frontal sinus punch, curved upwards,  
blunt end, with irrigation channel, 12.5 cm

Art.-Nr./No. Größe / Size (mm)

30-425-35	3,5
30-425-45	4,5

#### Vorteile / Advantages:

- Rückwärts schneidend / Backwards cutting
- Geringer Kraftaufwand / Little force required
- Besonders leichtgängig / Runs smoothly

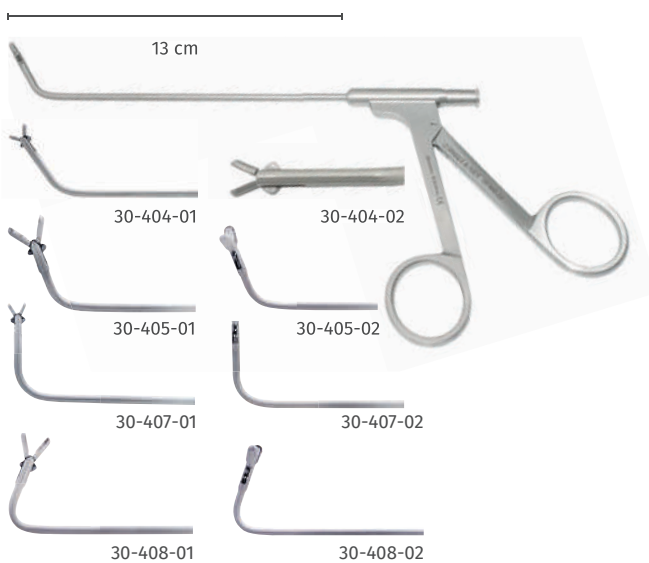

**Stirnhöhlen Löffelzange, oval, mit Spülkanal, 13 cm**  
Frontal sinus forceps, oval cups, with irrigation channel, 13 cm

Art.-Nr./No. Größe / Size (mm) Winkel / Angle

30-404-01	2	55°, vertikal / vertical
30-404-02	2	55°, horizontal
30-405-01	4	70°, vertikal / vertical
30-405-02	4	70°, horizontal
30-405-11	4	55°, vertikal / vertical
30-405-12	4	55°, horizontal
30-407-01	2	90°, vertikal / vertical
30-407-02	2	90°, horizontal
30-408-01	4	110°, vertikal / vertical
30-408-02	4	110°, horizontal

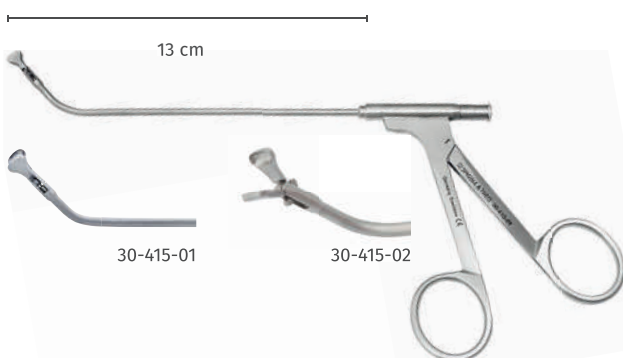

**Binner Polypenfasszange, 3 mm, mit Spülkanal, 13 cm**  
Binner polyp forceps, 3 mm, with irrigation channel, 13 cm

Art.-Nr./No. Winkel / Angle

30-415-01	45°, horizontal
30-415-02	80°, horizontal

## 06 Stirnhöhlen- und Keilbeinhöhlen-Instrumente

### Frontal and Sphenoidal Instruments

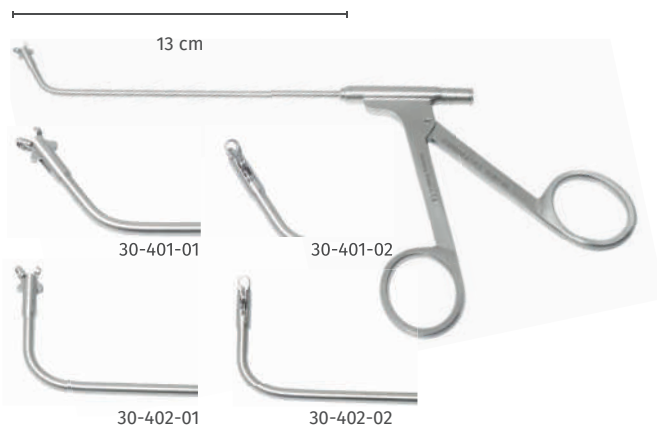

#### Stirnhöhlenzange, durchschneidend, 2 mm, mit Spülkanal

Frontal sinus forceps, throughcutting, 2 mm, with irrigation channel

Art.-Nr./No.	Größe / Size (cm)	Winkel / Angle
30-401-01	13	55°, vertikal / vertical
30-401-02	13	55°, horizontal
30-402-01	13	90°, vertikal / vertical
30-402-02	13	90°, horizontal

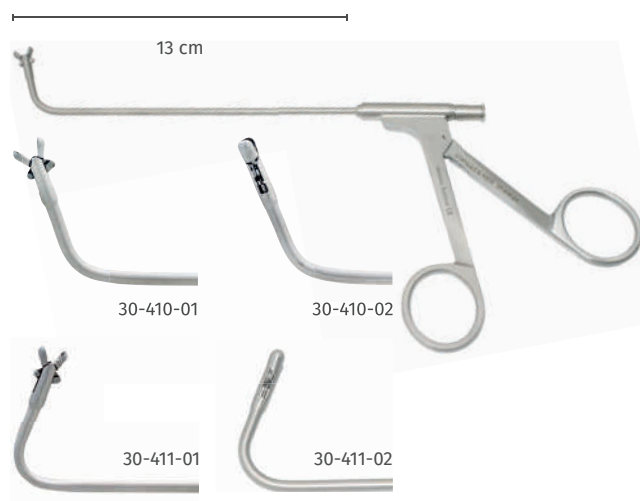

#### Stirnhöhlen Biopsiezange, 3 mm, mit Spülkanal, 13 cm

Frontal sinus biopsy forceps, 3 mm, with irrigation channel, 13 cm

Art.-Nr./No.	Winkel / Angle
30-410-01	70°, vertikal / vertical
30-410-02	70°, horizontal
30-411-01	110°, vertikal / vertical
30-411-02	110°, horizontal

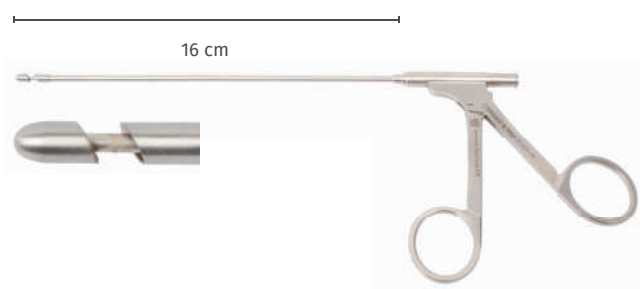

#### Rundkopfstanze für Keilbeinhöhle,

eiförmig, 60° Schnitt, mit Spülkanal, 16 cm

Sphenoid sinus circular punch, egg-formed, 60° cutting, with irrigation channel, 16 cm

Art.-Nr./No.	Größe / Size (mm)	Beschreibung / Description
30-429-35	3,5	gerade / straight
30-429-45	4,5	gerade / straight



## 06 Stirnhöhlen- und Keilbeinhöhlen-Instrumente

### Frontal and Sphenoidal Instruments

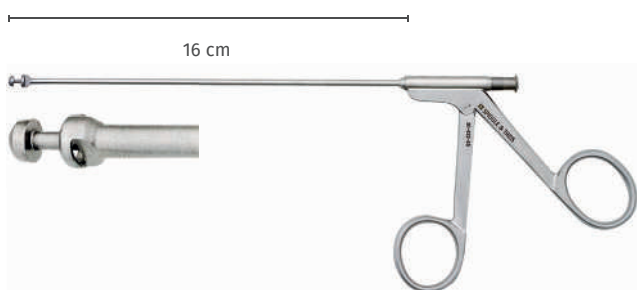

**Rundkopfstanze für Keilbeinhöhle, mit Spülkanal, 16 cm**  
**Sphenoid sinus circular punch, with irrigation channel, 16 cm**

Art.-Nr./No.	Größe / Size (mm)	Winkel / Angle
30-422-35	3,5	0°
30-422-45	4,5	0°



**Knochenstanze mit Reservoir, 2 mm, mit Mandrin, 19 cm**  
**Antrum punch with collector, 2 mm, with stylet, 19 cm**

**30-450-20**



**Mandrin zum Entfernen von Knochenmaterial aus Knochenstanzen**  
**Stylet for removal of bone residue from antrum punch**

**30-450-90**

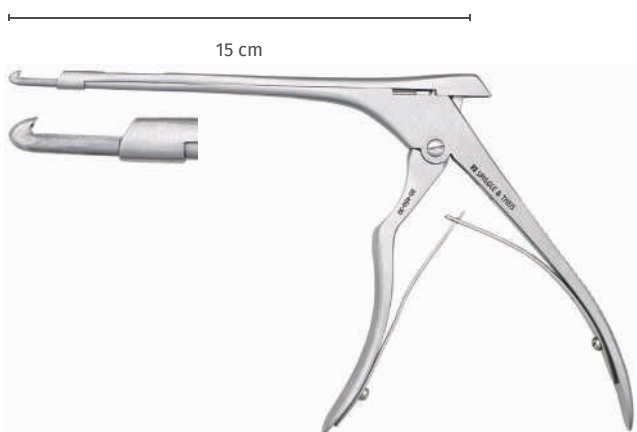

**Knochenstanze mit Reservoir, 3 mm, mit Mandrin, 15 cm**  
**Antrum punch with collector, 3 mm, with stylet, 15 cm**

**30-450-30**



## 06 Stirnhöhlen- und Keilbeinhöhlen-Instrumente

### Frontal and Sphenoidal Instruments

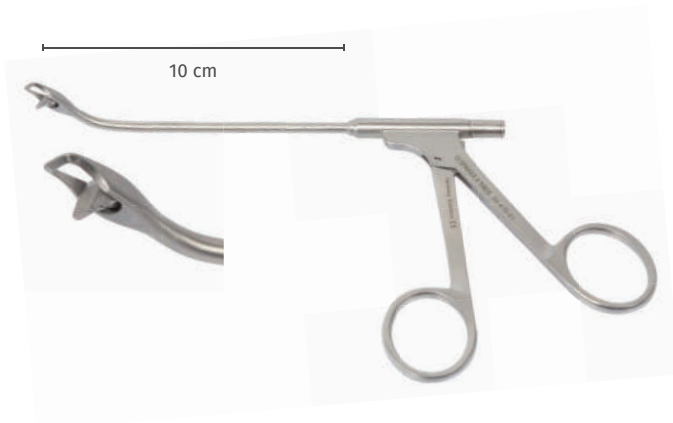

**Schwager Stanze für den Orbitaboden,  
mit Spülkanal, 45°, 3,5 mm, 10 cm**  
Schwager punch for orbita floor,  
with irrigation channel, 45°, 3.5 mm, 10 cm

Art.-Nr./No.	Beschreibung / Description
30-475-01	links / left
30-475-02	rechts / right

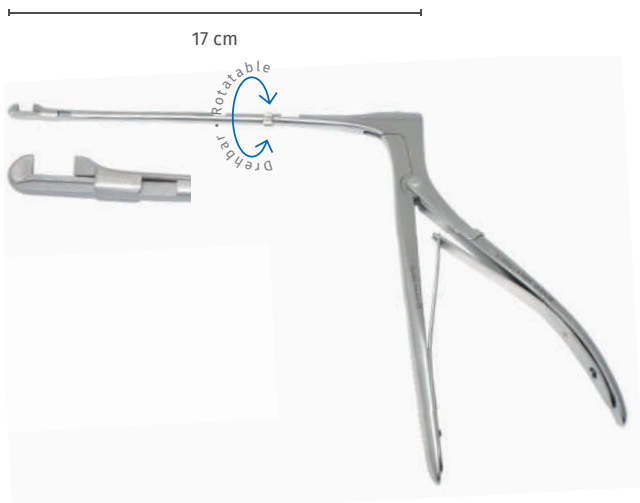

**Hajek-Kofler Keilbeinstanze, aufeinander schneidend,  
drehbar, 3 mm, 17 cm, zerlegbar**  
Hajek-Kofler sphenoid punch,  
rotatable, 3 mm, 17 cm, detachable

**30-456-32**



## 06 Stirnhöhlen- und Keilbeinhöhlen-Instrumente

### Frontal and Sphenoidal Instruments

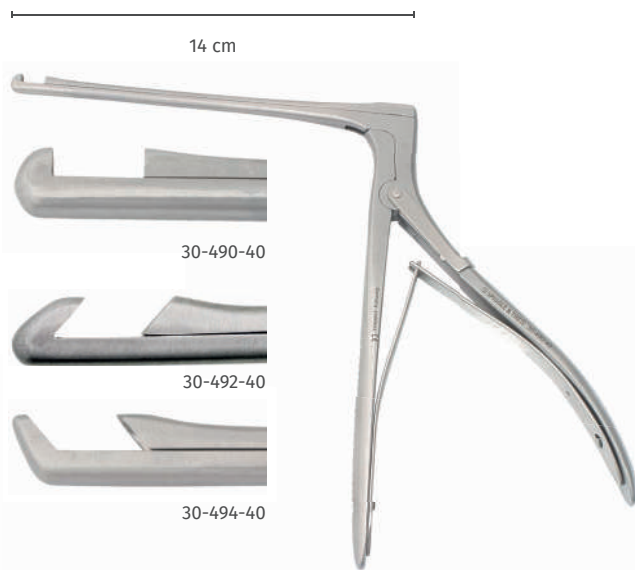

**Hajek-Kofler Keilbeinstanze, aufeinander schneidend, zerlegbar, 4 mm, 14 cm**

**Hajek-Kofler sphenoid punch, detachable, 4 mm, 14 cm**

Art.-Nr./No.	Winkel / Angle
30-490-40	90°, aufwärts / upwards
30-491-40	90°, abwärts / downwards
30-492-40	40°, aufwärts, rückwärts upwards, backwards
30-493-40	40°, abwärts, rückwärts downwards, backwards
30-494-40	40°, aufwärts, vorwärts upwards, forwards

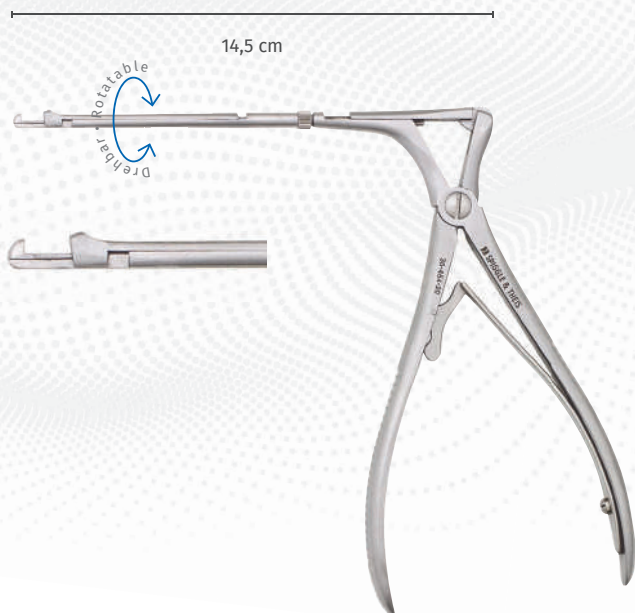

**McKenty Keilbeinstanze, durchschneidend, drehbar, 2 mm, 14,5 cm**

**McKenty sphenoid punch, throughcutting, rotatable, 2 mm, 14.5 cm**

**30-454-20**

## 06 Stirnhöhlen- und Keilbeinhöhlen-Instrumente

### Frontal and Sphenoidal Instruments

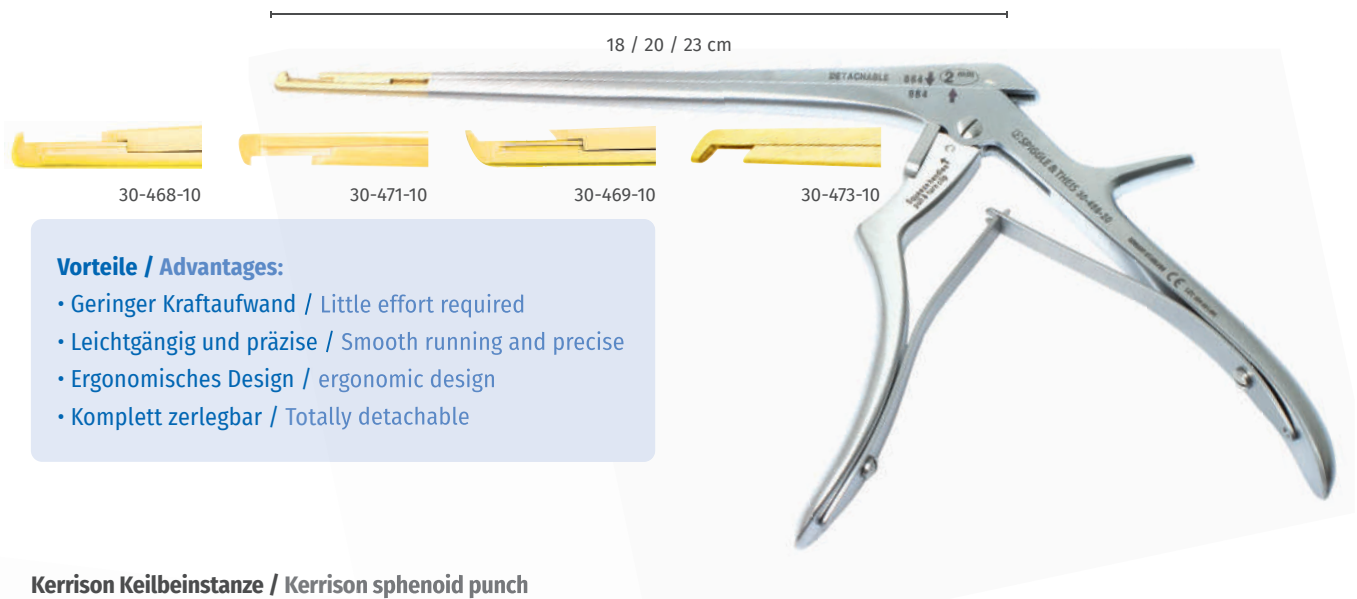

#### Vorteile / Advantages:

- Geringer Kraftaufwand / Little effort required
- Leichtgängig und präzise / Smooth running and precise
- Ergonomisches Design / ergonomic design
- Komplett zerlegbar / Totally detachable

#### Kerrison Keilbeinstanze / Kerrison sphenoid punch

Art.-Nr. Art.-No.	Größe Size (mm)	Länge Length (cm)	Winkel Angle
30-468-10	1	18	90° aufwärts / upwards
30-468-20	2	18	90° aufwärts / upwards
30-468-30	3	18	90° aufwärts / upwards
30-468-40	4	18	90° aufwärts / upwards
30-468-50	5	18	90° aufwärts / upwards
30-469-10	1	18	40° aufwärts / upwards
30-469-20	2	18	40° aufwärts / upwards
30-469-30	3	18	40° aufwärts / upwards
30-469-40	4	18	40° aufwärts / upwards
30-469-50	5	18	40° aufwärts / upwards
30-471-10	1	18	90° abwärts / downwards
30-471-20	2	18	90° abwärts / downwards
30-471-30	3	18	90° abwärts / downwards
30-473-10	1	18	40° abwärts / downwards
30-473-20	2	18	40° abwärts / downwards
30-473-30	3	18	40° abwärts / downwards
30-477-10	1	23	40° aufwärts / upwards
30-477-20	2	23	40° aufwärts / upwards
30-477-30	3	23	40° aufwärts / upwards
30-477-40	4	23	40° aufwärts / upwards
30-477-50	5	23	40° aufwärts / upwards
30-477-60	6	23	40° aufwärts / upwards
30-478-10	1	23	90° aufwärts / upwards
30-478-20	2	23	90° aufwärts / upwards
30-478-30	3	23	90° aufwärts / upwards
30-478-40	4	23	90° aufwärts / upwards
30-478-50	5	23	90° aufwärts / upwards
30-478-60	6	23	90° aufwärts / upwards

Art.-Nr. Art.-No.	Größe Size (mm)	Länge Length (cm)	Winkel Angle
30-479-10	1	23	90° abwärts / downwards
30-479-20	2	23	90° abwärts / downwards
30-479-30	3	23	90° abwärts / downwards
30-479-40	4	23	90° abwärts / downwards
30-479-50	5	23	90° abwärts / downwards
30-479-60	6	23	90° abwärts / downwards
30-483-10	1	20	40° aufwärts / upwards
30-483-20	2	20	40° aufwärts / upwards
30-483-30	3	20	40° aufwärts / upwards
30-483-40	4	20	40° aufwärts / upwards
30-483-50	5	20	40° aufwärts / upwards
30-483-60	6	20	40° aufwärts / upwards
30-484-10	1	20	90° aufwärts / upwards
30-484-20	2	20	90° aufwärts / upwards
30-484-30	3	20	90° aufwärts / upwards
30-484-40	4	20	90° aufwärts / upwards
30-484-50	5	20	90° aufwärts / upwards
30-484-60	6	20	90° aufwärts / upwards
30-485-10	1	20	90° abwärts / downwards
30-485-20	2	20	90° abwärts / downwards
30-485-30	3	20	90° abwärts / downwards
30-485-40	4	20	90° abwärts / downwards
30-485-50	5	20	90° abwärts / downwards
30-485-60	6	20	90° abwärts / downwards
30-485-10 TAN	1	20	90° abwärts, geschwärzt downwards, black coated
30-485-40 TAN	4	20	90° abwärts, geschwärzt downwards, black coated



## 07 Mikroskopische/Endoskopische Instrumente für die Pansinus-Chirurgie

### Microscopic/Endoscopic Instruments for Pansinus Surgery



**Flexibler Spannarm zur Verwendung mit selbsthaltenden NNH-Spekula, mit Verlängerungsstange**  
Flexible holding arm for use with self retaining nasal specula, inclusive holding rod

**30-700-00**



**Gelenkkloben zur Befestigung am OP-Tisch, passend für 30-700-00 und 40-337-00**  
Rotation clamp for fixation to operating table, for 30-700-00 and 40-337-00

**30-700-01**

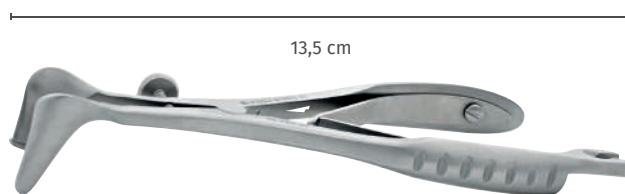

13,5 cm

**NNH-Spekulum für Kinder, linkes Blatt 25 mm, 13,5 cm**  
Sinus speculum for children, left blade 25 mm, 13.5 cm

**30-702-25**



13,5 cm

**NNH-Spekulum für Kinder, rechtes Blatt 25 mm, 13,5 cm**  
Sinus speculum for children, right blade 25 mm, 13.5 cm

**30-703-25**



15 cm

**NNH-Spekulum für Erwachsene, 15 cm**  
Sinus speculum for adults, 15 cm

Art.-Nr. Art.-No.	Größe Size (mm)	Beschreibung Description
30-705-55	55	linkes Blatt / left blade
30-705-65	65	linkes Blatt / left blade
30-705-75	75	linkes Blatt / left blade
30-706-55	55	rechtes Blatt / right blade
30-706-65	65	rechtes Blatt / right blade
30-706-75	75	rechtes Blatt / right blade

## 07 Mikroskopische/Endoskopische Instrumente für die Pansinus-Chirurgie

### Microscopic/Endoscopic Instruments for Pansinus Surgery

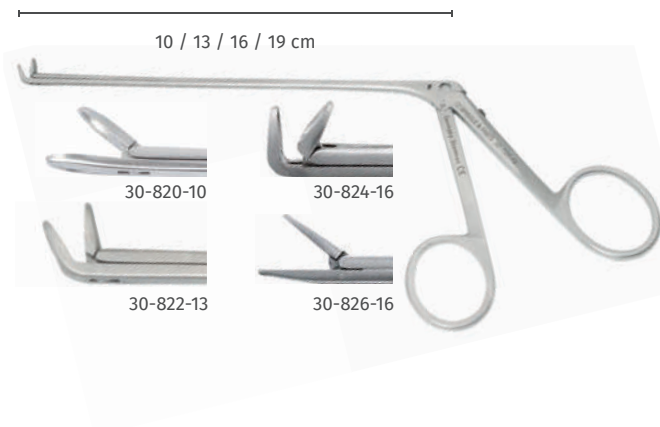

#### Draf Siebbeinzängchen / Draf ethmoid forceps

Art.-Nr. Art.-No.	Größe Size (mm)	Länge Length (cm)	Winkel Angle
30-820-10	6,0 x 2,5	10	gerade / straight
30-820-13	6,0 x 2,5	13	gerade / straight
30-820-16	6,0 x 2,5	16	gerade / straight
30-820-19	6,0 x 2,5	19	gerade / straight
30-822-13	6,0 x 2,5	13	55° aufgebogen / angled
30-822-16	6,0 x 2,5	16	55° aufgebogen / angled
30-822-19	6,0 x 2,5	19	55° aufgebogen / angled
30-824-13	6,0 x 2,5	13	90° aufgebogen / angled
30-824-16	6,0 x 2,5	16	90° aufgebogen / angled
30-824-19	6,0 x 2,5	19	90° aufgebogen / angled
30-826-16	4,0 x 1,8	16	gerade / straight



#### Draf Siebbeinzängchen, gerade, fein gerieft

#### Draf ethmoid forceps, straight, finely serrated

Art.-Nr./No.	Größe / Size (mm)	Länge / Length (cm)
30-828-16	6,0 x 1,0 x 2,0	16
30-828-19	6,0 x 1,0 x 2,0	19



#### Draf Siebbeinzängchen, gerade, grob gerieft, 16 cm

#### Draf ethmoid forceps, straight, coarsely serrated, 16 cm

**30-829-16**



#### Draf Siebbeinscherchen / Draf ethmoid scissors

Art.-Nr. Art.-No.	Länge Length (cm)	Winkel Angle
30-832-13	13	gerade / straight
30-832-16	16	gerade / straight
30-832-19	19	gerade / straight
30-833-16	16	links gebogen / curved left
30-834-16	16	rechts gebogen / curved right
30-835-19	19	45° aufwärts gebogen 45° curved upwards



## 07 Mikroskopische/Endoskopische Instrumente für die Pansinus-Chirurgie

### Microscopic/Endoscopic Instruments for Pansinus Surgery

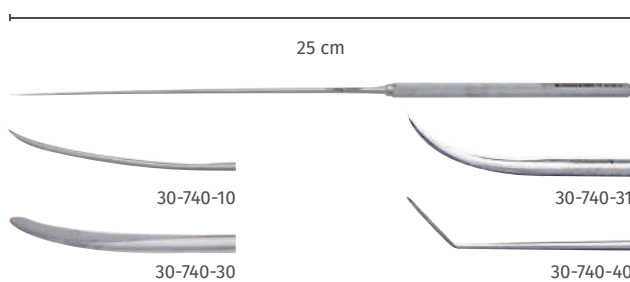

**Draf Mikroraspatorium, 25 cm / Draf micro raspatory, 25 cm**

Art.-Nr. Art.-No.	Größe Size (mm)	Beschreibung Description
30-740-10	1	leicht gebogen / slightly curved
30-740-30	3	leicht gebogen / slightly curved
30-740-31	3	stark gebogen / strongly curved
30-740-40	4	gewinkelt / angled

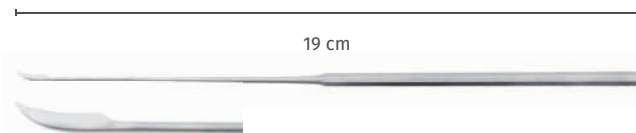

**Draf Sichelmesser, 19 cm, gebogen**

**Draf sickle knife, 19 cm, curved**

**30-742-19**



**Draf Rundschnittmesser, 1,5 mm, 19 cm**

**Draf round knife, 1.5 mm, 19 cm**

**30-743-19**



**Draf Incisionsmesser, 19 cm / Draf flap knife, 19 cm**

**30-744-19**

## 07 Mikroskopische/Endoskopische Instrumente für die Pansinus-Chirurgie

### Microscopic/Endoscopic Instruments for Pansinus Surgery

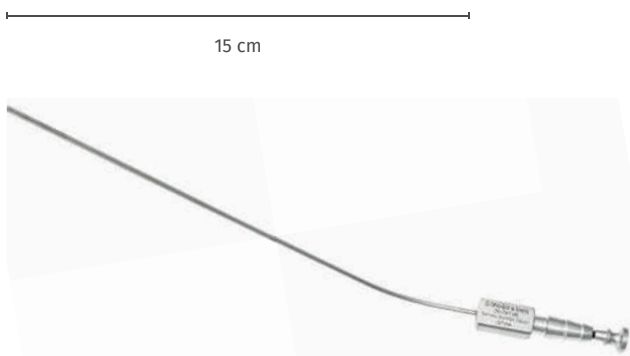

**Frazier Saugrohr, 15 cm / Frazier suction tube, 15 cm**

Art.-Nr./No.	Ch/Fr	mm
30-747-06	6	2,0
30-747-07	7	2,3
30-747-08	8	2,7
30-747-09	9	3,0
30-747-10	10	3,3
30-747-12	12	4,0
30-747-15	15	5,0

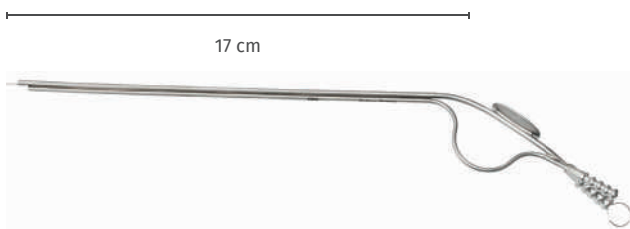

**Saug- und Spülrohr, Saugrohr 2,5 mm, Spülrohr 2,0 mm, 17 cm**  
**Suction / irrigation tube, suction tube 2.5 mm,**  
**irrigation tube 2.0 mm, 17 cm**

**30-749-15**

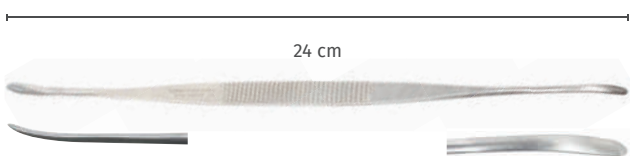

**Raspa Tönnis, Größen 3 mm & 5 mm, 24 cm**  
**Tönnis raspatory, sizes 3 mm & 5 mm, 24 cm**

**30-759-21**





## 07 Mikroskopische/Endoskopische Instrumente für die Pansinus-Chirurgie

### Microscopic/Endoscopic Instruments for Pansinus Surgery



**Bipolare Koagulationspinzette, NON-STICK, bajonett, Führungsstift 22,5 cm**  
**Bipolar coagulation forceps, NON-STICK, bayonet, guide pin, 22.5 cm**

Art.-Nr./No.	Spitze / Tip (mm)
80-125-03	0,3
80-125-07	0,7
80-125-12	1,2

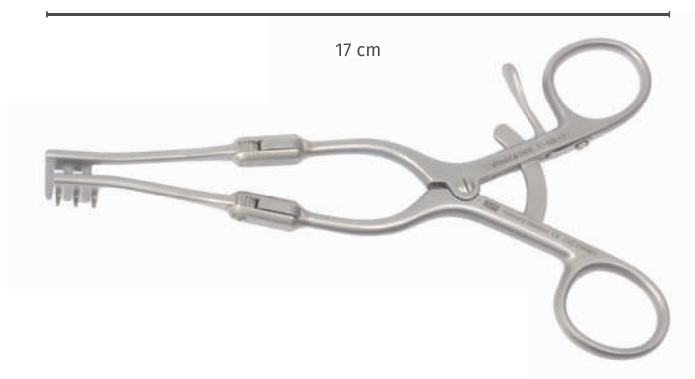

**Fisch Wundsperrer mit Gelenken, 17 cm**  
**Fisch retractor, jointed, 17 cm**

Art.-Nr./No.	3:3 Zähne, halbscharf 3:3 prongs, semi-sharp
10-468-17	

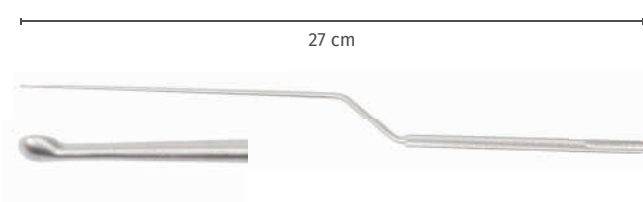

**Löffelkürette, halbscharf, bajonett, gerade, nach oben, 2 mm, 27 cm**  
**Spoon curette, semi-sharp, bayonet, straight, upwards, 2 mm, 27 cm**

90-201-01

## 07 Mikroskopische/Endoskopische Instrumente für die Pansinus-Chirurgie

### Microscopic/Endoscopic Instruments for Pansinus Surgery

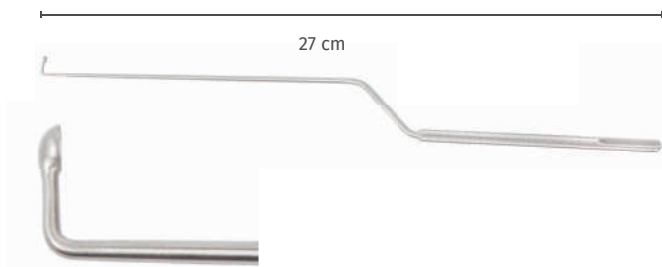

**Löffelkürette, halbscharf, bajonett, 90° nach oben gebogen, mit 5 mm Steg, 27 cm**

**Spoon curette, semi-sharp, bayonet, 90° curved upwards, with 5 mm bar, 27 cm**

Art.-Nr./No. Größe / Size (mm)

90-201-02	2
90-201-03	3

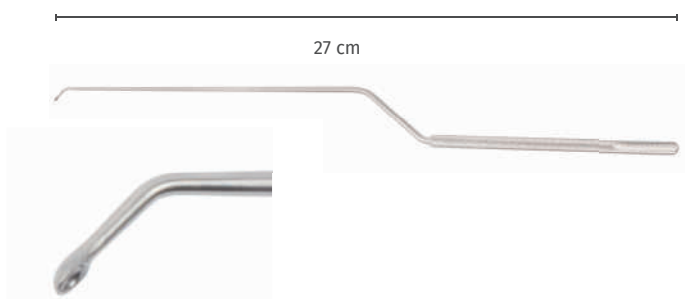

**Löffelkürette, halbscharf, bajonett, mit 5 mm Steg, 27 cm**

**Spoon curette, semi-sharp, bayonet, with 5 mm bar, 27 cm**

Art.-Nr. Größe Winkel  
Art.-No. Size (mm) Angle

90-201-04	2	45° nach unten gebogen 45° curved downwards
90-201-05	2	45° nach oben gebogen 45° curved upwards
90-201-06	4	45° nach unten gebogen 45° curved downwards
90-201-07	4	45° nach oben gebogen 45° curved upwards

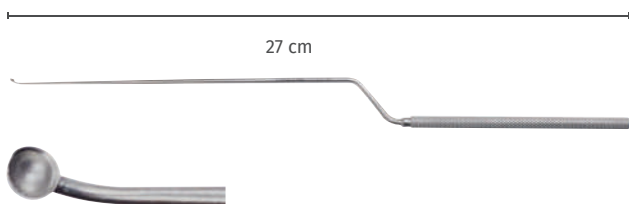

**Löffelkürette, halbscharf, bajonett,**

**45° leicht nach oben gebogen, mit 5 mm Steg, 27 cm**

**Spoon curette, semi-sharp, bayonet,**

**45° slightly curved upwards, with 5 mm bar, 27 cm**

Art.-Nr./No. Größe / Size (mm)

90-201-08	2
90-201-09	4



## 07 Mikroskopische/Endoskopische Instrumente für die Pansinus-Chirurgie

### Microscopic/Endoscopic Instruments for Pansinus Surgery

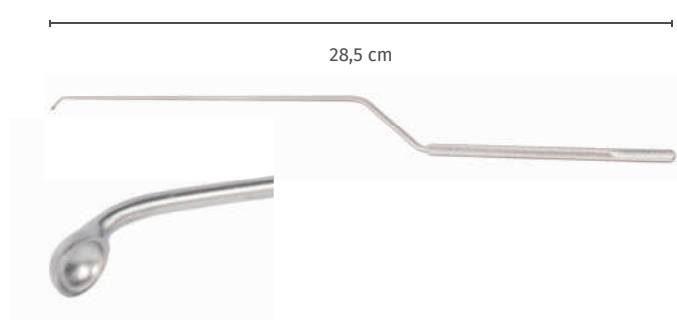

**Löffelkürette, halbscharf, bajonett, mit 5 mm Steg, 28,5 cm**  
**Spoon curette, semi-sharp, bayonet, with 5 mm bar, 28.5 cm**

Art.-Nr./No.	Größe / Size (mm)	Winkel / Angle
90-201-14	2	45° nach unten gebogen 45° curved downwards
90-201-15	2	45° nach oben gebogen 45° curved upwards
90-201-16	4	45° nach unten gebogen 45° curved downwards
90-201-17	4	45° nach oben gebogen 45° curved upwards

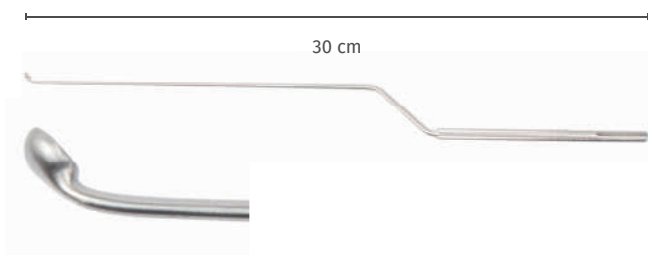

**Löffelkürette, halbscharf, bajonett, 30 cm**  
**Spoon curette, semi-sharp, bayonet, 30 cm**

Art.-Nr./No.	Größe / Size (mm)	Winkel / Angle
90-201-18	2	45° leicht nach oben gebogen 45° slightly curved upwards
90-201-19	4	45° leicht nach oben gebogen 45° slightly curved upwards
90-201-28	2	45° leicht nach unten gebogen 45° slightly curved downwards
90-201-29	4	45° leicht nach unten gebogen 45° slightly curved downwards

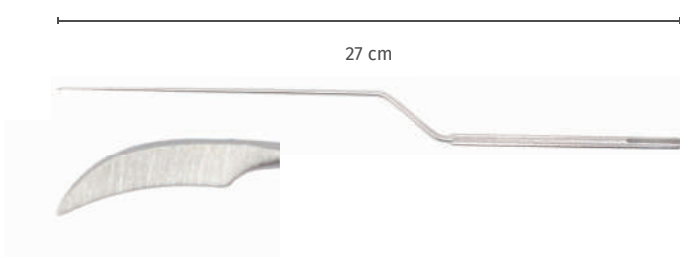

**Sichelmesser spitz, bajonett, 27 cm**  
**Sickle knife pointed, bayonet, 27 cm**

Art.-Nr./No.	Beschreibung / Description
90-202-01	nach rechts gebogen / curved right
90-202-02	nach links gebogen / curved left

## 07 Mikroskopische/Endoskopische Instrumente für die Pansinus-Chirurgie

### Microscopic/Endoscopic Instruments for Pansinus Surgery

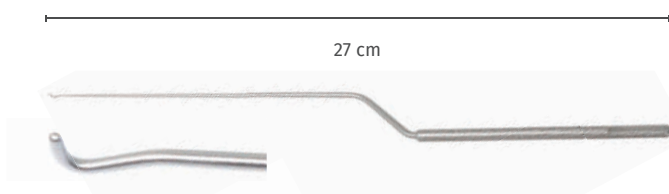

**Enucleator, Rändelgriff, bajonett, 27 cm**  
**Enucleator, knurled handle, bayonet, 27 cm**

Art.-Nr./No.	Beschreibung / Description
90-204-01	nach links gebogen / curved left
90-204-02	nach rechts gebogen / curved right

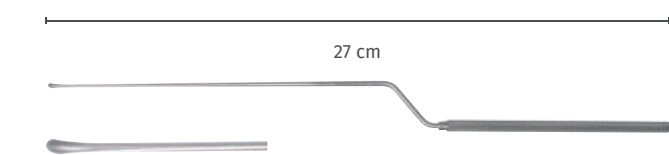

**Raspatorium, scharf, bajonett, 27 cm**  
**Raspatory, sharp, bayonet, 27 cm**

Art.-Nr./No.	Beschreibung / Description
90-206-01	nach links gebogen / curved left
90-206-02	nach rechts gebogen / curved right
90-206-03	nach unten gebogen / curved downwards
90-206-04	nach oben gebogen / curved upwards

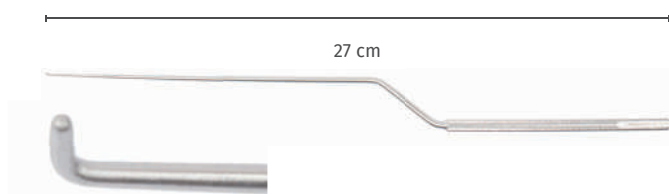

**Sondenhäkchen, stumpf, bajonett, 27 cm**  
**Probe hook, blunt, bayonet, 27 cm**

Art.-Nr./No.	Beschreibung / Description
90-208-01	nach links gebogen / curved left
90-208-02	nach rechts gebogen / curved right

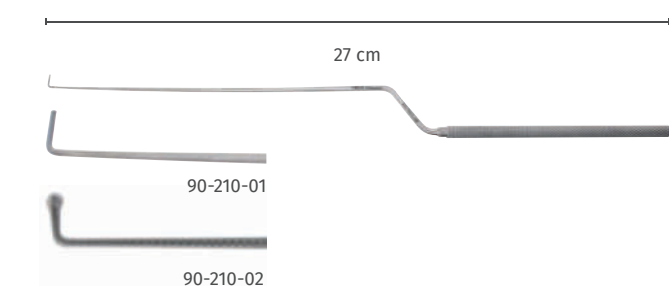

**Haken, nach oben gebogen, 90°, bajonett, 27 cm**  
**Hook, curved upwards, 90°, bayonet, 27 cm**

Art.-Nr. Art.-No.	Größe Size (mm)	Beschreibung Description
90-210-01		stumpf / blunt
90-210-02	1	mit Sondenkopf / with ball end



## 07 Mikroskopische/Endoskopische Instrumente für die Pansinus-Chirurgie

### Microscopic/Endoscopic Instruments for Pansinus Surgery

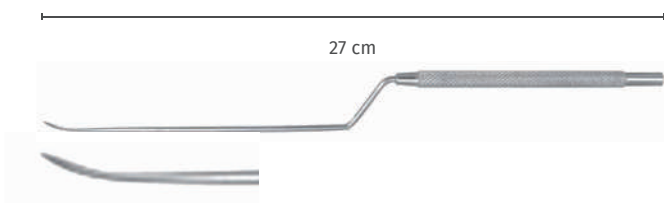

**Dissektor, stumpf, nach oben gebogen, 3 mm, bajonett, 27 cm**  
**Dissector, blunt, curved upwards, 3 mm, bayonet, 27 cm**

**90-210-03**

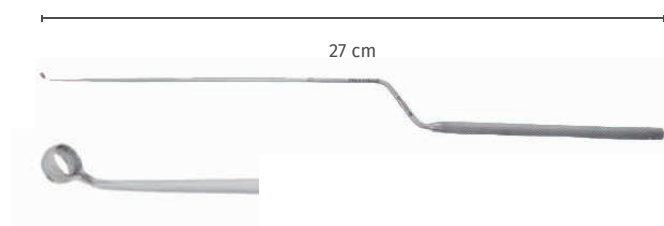

**Ringkürette, scharf, nach oben gebogen, bajonett, 27 cm**  
**Ring curette, sharp, curved upwards, bayonet, 27 cm**

Art.-Nr./No.	Größe / Size (mm)	Winkel / Angle
90-210-04	2	45°
90-210-05	2	90°
90-210-06	4	45°
90-210-07	4	90°
90-210-08	5	90°

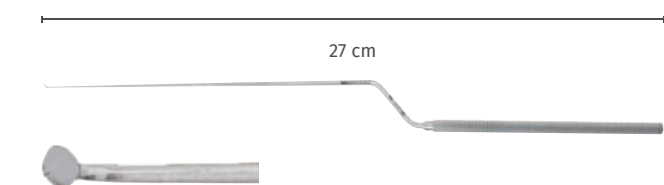

**Tellermesser, nach oben gebogen, 45°, bajonett, 27 cm**  
**Separator, curved upwards, 45°, bayonet, 27 cm**

Art.-Nr./No.	Größe / Size (mm)
90-210-09	1,5
90-210-10	3,5

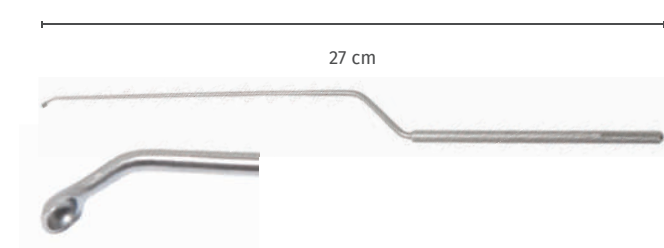

**Löffelkürette, halbscharf, nach unten gebogen, 2,5 mm, 45°, bajonett, 27 cm**  
**Spoon curette, semi-sharp, curved downwards, 2.5 mm, 45°, bayonet, 27 cm**

**90-211-01**

## 07 Mikroskopische/Endoskopische Instrumente für die Pansinus-Chirurgie

### Microscopic/Endoscopic Instruments for Pansinus Surgery

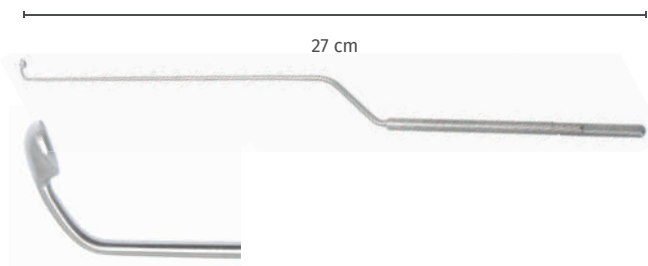

**Löffelkürette, halbscharf, bajonett, 27 cm**  
**Spoon curette, semi-sharp, bayonet, 27 cm**

Art.-Nr. Art.-No.	Größe Size (mm)	Winkel Angle
90-212-01	4,5	leicht nach oben gebogen slightly curved upwards
90-212-02	4,5	stark nach oben gebogen strongly curved upwards
90-212-03	4,5	45° nach oben gebogen 45° curved upwards

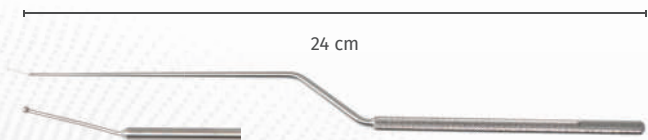

**Knopfsonde, bajonett, Sonde gewinkelt, 9,5 mm, 24 cm**  
**Ball-end probe, bayonet, probe angled, 9.5 mm, 24 cm**

**90-213-00**

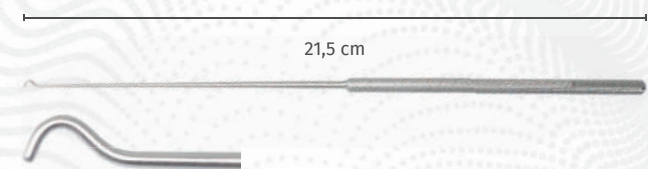

**Mikro-Häkchen, vorwärts/rückwärts, stumpf, gerade, 21,5 cm**  
**Micro hook, forward/backward, blunt, straight, 21.5 cm**

**90-214-00**

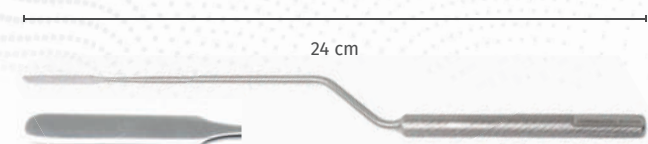

**Mukosa Dissektor, bajonett, 30 x 6 mm, 24 cm**  
**Mucosa dissector, bayonet, 30 x 6 mm, 24 cm**

**90-215-00**



## 07 Mikroskopische/Endoskopische Instrumente für die Pansinus-Chirurgie

### Microscopic/Endoscopic Instruments for Pansinus Surgery

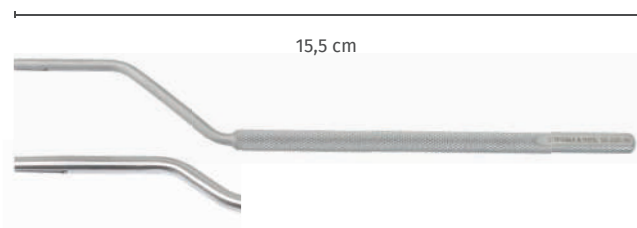

**Spiegel-Griff, bajonett, rund gerändelt, 15,5 cm**  
**Mirror handle, bayonet, knurled, 15.5 cm**

**90-220-00**

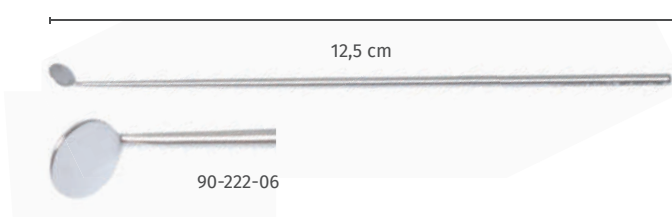

**Spiegel, rund, hochglanzpoliert, extra fein, 12,5 cm,**  
**zur Verwendung mit Handgriff 90-220-00**

**Mirror, round, polished, very fine, 12.5 cm,**  
**for use with handle 90-220-00**

Art.-Nr./No.	Größe / Size (mm)
90-222-04	4
90-222-05	5
90-222-06	6
90-222-08	8
90-222-10	10
90-222-12	12





**Halle Kieferhöhlenkürette, doppelseitig, 21 cm**  
Halle antrum curette, double ended, 21 cm

30-805-00

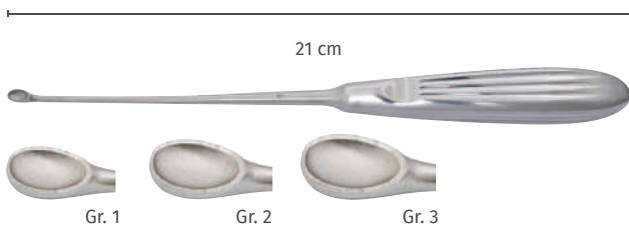

**Halle Kieferhöhlenlöffel, biegsam, 21 cm**  
Halle antrum curette, bendable, 21 cm

Art.-Nr./No.	Größe / Size (mm)
30-807-01	1
30-807-02	2
30-807-03	3

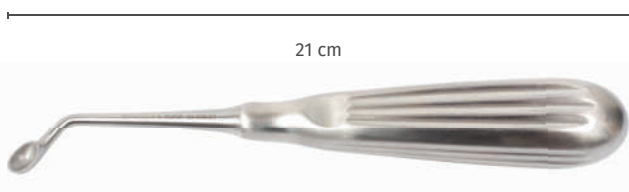

**Uffenorde Kieferhöhlenlöffel, 21 cm**  
Uffenorde antrum curette, 21 cm

Art.-Nr./No.	Beschreibung / Description
30-809-01	links gebogen / curved left
30-809-02	rechts gebogen / curved right



**Orbitaschützer, 23 cm / Orbita protector, 23 cm**  
30-812-24

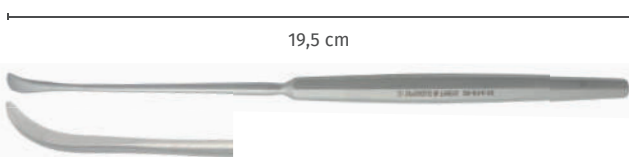

**Sewall Kieferhöhlenelevatorium, 19,5 cm**  
Sewall antrum elevator, 19.5 cm

30-814-19



**West Hohlmeißel, 4 mm, 18 cm / West gouge, 4 mm, 18 cm**  
30-816-40



**West Flachmeißel, 4,5 mm, 18 cm / West chisel, 4.5 mm, 18 cm**  
30-817-40



## 08 Allgemeines Miscellaneous



80-262-12



80-260-12

### 1/2 EdelstahlSiebkorb und Deckel, aus perforiertem Blech, ohne FüÙe 1/2 Stainless steel perforated basket and lid, without feet

Art.-Nr./No.	Beschreibung Description	Größe / Size (mm)
80-260-12	Korb / basket	243 x 253 x 47
80-262-12	Deckel / lid	244 x 254



80-261-35



80-260-35

### EdelstahlSiebkorb und Deckel, Dental, aus perforiertem Blech, ohne FüÙe Stainless steel perforated basket and lid, dental, without feet

Art.-Nr./No.	Beschreibung Description	Größe / Size (mm)
80-260-35	Korb / basket	270 x 175 x 35
80-261-35	Deckel / lid	273 x 178



80-261-42



80-260-42

### EdelstahlSiebkorb und Deckel, mini, aus perforiertem Blech, ohne FüÙe Stainless steel perforated basket and lid, mini, without feet

Art.-Nr./No.	Beschreibung Description	Größe / Size (mm)
80-260-42	Korb / basket	265 x 120 x 42
80-261-42	Deckel / lid	267 x 122

### Edelstahlleiste für Silikonhalterungen mit T-Profil, passend für 80-270-24 & 80-272-24 Stainless steel bar rail for silicone holders, compatible with 80-270-24 & 80-272-24



80-275-11

Art.-Nr./No.	Größe / Size (mm)
80-275-11	117
80-275-23	23
80-275-40	40
80-275-50	50

### Schraube C3,5x13 H, Kopf ø 6,6 mm Screw C3.5x13 H, screw head ø 6.6 mm

80-280-01



80-302-12      80-302-14      80-302-16

**Sternberg Lippenhaken / Sternberg lip retractor**

Art.-Nr./No.	Größe / Size (cm)
80-302-12	12
80-302-14	14
80-302-16	16

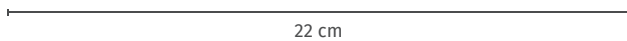

22 cm



80-306-17      80-306-22      80-306-30

**Middeldorpf Wundhaken, 22 cm / Middeldorpf retractor, 22 cm**

Art.-Nr./No.	Größe / Size (mm)
80-306-17	14 x 17
80-306-22	20 x 22
80-306-30	26 x 30



21 cm



80-308-07      80-308-10      80-308-15      80-308-20

**Langenbeck Wundhaken, 21 cm / Langenbeck retractor, 21 cm**

Art.-Nr./No.	Größe / Size (mm)
80-308-07	35 x 7
80-308-10	35 x 10
80-308-15	35 x 15
80-308-20	60 x 20

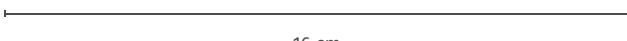

16 cm



**Langenbeck-Green Wundhaken, Flachgriff, 24 x 6 mm, 16 cm  
Langenbeck-Green retractor, flat handle, 24 x 6 mm, 16 cm**

**80-334-16**



**Spezial Ölspray, Pflegespray für Instrumente sowie für  
Hand- und Winkelstücke, 500 ml  
Special Oilspray, Maintenance Spray for Instruments and Drill  
Handpieces, 500 ml**

**00-108-005**





**Metallschale / Metal bowl**

Art.-Nr. Art.-No.		Durchmesser Diameter (mm)	Höhe Height (mm)	Fassungs- vermögen Capacity (ml)
80-501-01	B1	Ø 40	H=19	20
80-501-02	B2	Ø 60	H=29	60
80-501-03	B3	Ø 85	H=40	160
80-501-04	B4	Ø 110	H=55	400



**Medizinbecher, Edelstahl, graduiert  
Medicine cup, stainless steel, graduated**

Art.-Nr. Art.-No.		Durchmesser Diameter (mm)	Höhe Height (mm)	Fassungs- vermögen Capacity (ml)
80-503-03		Ø 50	H=25	30
80-504-05		Ø 53	H=45	50



**Lösungsschale, Edelstahl / Solution bowl, stainless steel**

Art.-Nr. Art.-No.		Durchmesser Diameter (mm)	Höhe Height (mm)	Fassungs- vermögen Capacity (ml)
80-506-30	B1	Ø 95	H=60	300
80-507-40	B2	Ø 120	H=70	500
80-509-75	B3	Ø 150	H=75	750



**Tablettenschale, Edelstahl, Ø 65 mm, H=20 mm  
Tablet dish, stainless steel, Ø 65 mm, H=20 mm**

**80-512-00**



**Petrischale, Klarglas, mit Deckel / Petri dish, clear glass, with lid**

Art.-Nr./No.	AD / OD (mm)	Höhe / Height (mm)
80-515-06	60	15
80-515-08	80	15
80-515-10	150	20

**Medikamenten-Schälchen, Dappenglas, farbig, Ø 3,2 cm**  
**Medication dish, dappen-glass, colored, Ø 3.2 cm**



Art.-Nr./No.	Farbe / Color
80-519-00	kristall / crystal
80-519-01	grün / green
80-519-02	rosa / pink
80-519-03	topas / topaz

**Porzellan-Schälchen, rund, mit Ausguss**  
**China bowl, round, with spout**



Art.-Nr./No.	Durchmesser / Diameter (cm)
80-520-06	Ø 8
80-520-08	Ø 10

**Nierenschale, Edelstahl / Kidney bowl, stainless steel**



Art.-Nr./No.	Größe / Size (cm)
80-525-17	17,5
80-525-25	25,0

**Kornzangen-Behälter, Edelstahl / Forceps holder, stainless steel**



Art.-Nr. Art.-No.	Durchmesser Diameter (cm)	Höhe Height (cm)
80-528-13	Ø 5,0	13,5
80-528-18	Ø 5,0	18,0
80-528-20	Ø 9,5	20,0

**Kornzangen-Behälter, Glas, Edelstahldeckel mit Ausschnitt,  
 Ø 8 cm, Höhe 20 cm**

**Forceps holder, glass, stainless steel lid with opening,  
 Ø 8 cm, height 20 cm**



**80-530-20**



## 09 Sterilisationssysteme

### Sterilization Systems



**Norm-Sterilisations-Container, Boden geschlossen**  
Norm sterilization container, bottom closed

Art.-Nr. Art.-No.	Größe Size	Dimension (außen) Dimension (outside) (mm)
80-631-10	1/2	297 x 274 x 88
80-631-12	1/2	297 x 274 x 123
80-631-14	1/2	297 x 274 x 138
80-631-21	1/2	297 x 274 x 188
80-641-14	3/4	462 x 274 x 138
80-661-12	1	585 x 274 x 123
80-661-14	1	585 x 274 x 138
80-661-21	1	585 x 274 x 188



**Ventildeckel für Norm-Sterilisations-Container**  
Valve lid for norm sterilization container

Art.-Nr./No. 1/2 299 x 278 mm	Art.-Nr./No. 3/4 462 x 278 mm	Art.-Nr./No. 1 585 x 278 mm
80-632-00 ●	80-642-00 ●	80-662-00 ●
80-632-01 ●	80-642-01 ●	80-662-01 ●
80-632-02 ●	80-642-02 ●	80-662-02 ●
80-632-03 ●	80-642-03 ●	80-662-03 ●
80-632-04 ●	80-642-04 ●	80-662-04 ●
80-632-05 ●	80-642-05 ●	80-662-05 ●



**Edelstahl-Siebkorb, Geflecht, Fallgriffe**  
Stainless-steel wire basket, sliding handles

Art.-Nr./No.	Größe / Size (mm)
80-671-20	255 x 245 x 50
80-671-25	255 x 245 x 70
80-671-40	405 x 255 x 70
80-671-60	485 x 255 x 70



**Aluminium-Kennzeichnungs-Schild, 20 Zeichen, 56 x 17 mm**  
Coding label, 20 letters, 56 x 17 mm

Art.-Nr./No.	Farbe / Color
80-681-01	schwarz / black
80-681-02	rot / red
80-681-03	braun / brown
80-681-04	grün / green
80-681-05	gelb / yellow
80-681-06	lila / purple
80-681-07	blau / blue



**Einweg-Container-Siegel, blau, 100 Stück/Box**  
 Container seal, disposable, blue, 100 pieces/box

**80-683-10**

**Indikator-Klebe-Etikett, Lasche rechts, 100 Stück/Box**  
 Adhesive indicator label, latch right side, 100 pieces/box

**80-684-10**



**Klemmschild aus Edelstahl, hitzebeständig,**  
**6 x 4 cm, 25 Stück/Box**  
 Label holder with clip, stainless steel, heat resistant,  
 6 x 4 cm, 25 pieces/box

**80-688-00**

**Endoskopie-Siebkorb mit Deckel, Edelstahl, elektropliert**  
 Endoscope container with lid, stainless steel, e-polished

Art.-Nr./No.	Größe / Size (cm)
80-690-01	29 x 8 x 5,2 für 1 Endoskop 29 x 8 x 5,2 for 1 endoscope
80-690-02	29 x 8 x 5,2 für 2 Endoskope 29 x 8 x 5,2 for 2 endoscopes

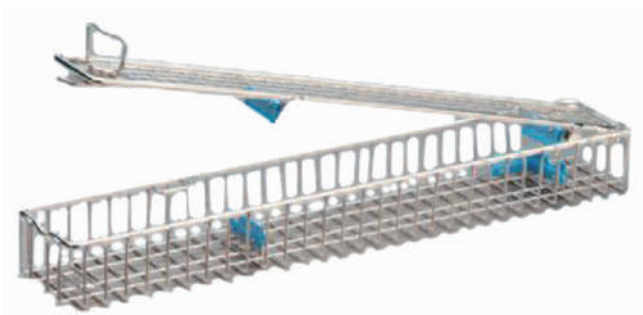

**Endoskopie-Siebkorb mit Deckel, Edelstahl, elektropliert**  
 Endoscope container with lid, stainless steel, e-polished

Art.-Nr./No.	Größe / Size (cm)
80-691-01	46 x 8 x 5,2 für 1 Endoskop 46 x 8 x 5,2 for 1 endoscope
80-692-01	67 x 8 x 5,2 für 1 Endoskop 67 x 8 x 5,2 for 1 endoscope



**Sterilisations- und Aufbewahrungssystem "Instru-Safe" für NNH-Set,**  
**270 x 245 x 152 mm**

**Sterilisation and protection system "Instru-Safe" for sinus surgery set,**  
**270 x 245 x 152 mm**

#### Vorteile / Advantages:

- Halterung für 20 Nasenzangen / Segments for 20 nasal forceps
- Leerraum für sperrige Instrumente / Space for bulky instruments
- Silikon-Noppen-Matte für feine Instrumente  
Silicone finger for delicate instruments

**80-611-10**





## 10 FESS - Basis-Set

### FESS - Basic-Set

#### Bestehend aus / Consisting of:

30-143-00	1x Sinuskop, HD, autoklavierbar, 4,0 mm, AL 175 mm, 0° 1x Sinuscope, HD, autoclavable, 4.0 mm, WL 175 mm, 0°	20-215-01	1x Blakesley Nasenzange, gerade, Gr. 1 1x Blakesley nasal forceps, straight, size 1
30-142-45	1x Sinuskop, HD, autoklavierbar, 4,0 mm, AL 175 mm, 45° 1x Sinuscope, HD, autoclavable, 4.0 mm, WL 175 mm, 45°	20-225-02	1x Blakesley Nasenzange, 45° aufgebogen, Gr. 2 1x Blakesley nasal forceps, 45° curved upwards, size 2
30-143-70	1x Sinuskop, HD, autoklavierbar, 4,0 mm, AL 175 mm, 70° 1x Sinuscope, HD, autoclavable, 4.0 mm, WL 175 mm, 70°	20-235-03	1x Blakesley Nasenzange, 90° aufgebogen, Gr. 3 1x Blakesley nasal forceps, 90° curved upwards, size 3
20-100-01	1x Hartmann Nasenspekulum für Erwachsene 1x Hartmann nasal speculum for adults	20-690-01	1x Conchotomie Schere, gerade 1x Nasal concha scissors, straight
20-150-75	1x Killian-Struycken Septumspikulum, 75 mm 1x Killian-Struycken nasal speculum, 75 mm	30-320-01	1x Durchschneidende Nasenzange, 5,0 x 1,5 mm, gerade 1x Throughcutting nasal forceps, 5.0 x 1.5 mm, straight
30-101-30	1x Eicken Spülröhrchen, kurze Biegung, Ø 3,0 mm 1x Eicken antrum cannula, short curve, Ø 3.0 mm	30-320-02	1x Durchschneidende Nasenzange, 6,0 x 2,5 mm, gerade 1x Throughcutting nasal forceps, 6.0 x 2.5 mm, straight
30-102-30	1x Eicken Spülröhrchen, kurze Biegung, Ø 3,0 mm 1x Eicken antrum cannula, short curve, Ø 3.0 mm	30-321-01	1x Durchschneidende Nasenzange, 60° gewinkelt, 5,0 x 1,5 mm 1x Throughcutting nasal forceps, 60° angled, 5.0 x 1.5 mm
30-122-08	1x Injektionskanüle, kniegebogen, 0,8 mm 1x Injection needle, angled, 0.8 mm	30-322-02	1x Durchschneidende Nasenzange, aufgebogen, 6,5 x 2,5 mm 1x Throughcutting nasal forceps, curved upwards, 6.5 x 2.5 mm
30-082-10	1x Frazier Saugrohr, Knopfende, 10 Ch/Fr 1x Frazier suction tube, ball ended, 10 Ch/Fr	30-304-25	1x Antrumstanze, rückwärts schneidend, drehbar, 2,5 mm 1x Antrum punch, backward cutting, rotatable, 2.5 mm
30-082-12	1x Frazier Saugrohr, Knopfende, 12 Ch/Fr 1x Frazier suction tube, ball ended, 12 Ch/Fr	30-468-20	1x Kerrison Keilbeinstanze, zerlegbar, 2 mm, 90° aufwärts 1x Kerrison sphenoid punch, detachable, 2 mm, 90° upwards
30-082-15	1x Frazier Saugrohr, Knopfende, 15 Ch/Fr 1x Frazier suction tube, ball ended, 15 Ch/Fr	30-333-02	1x Herberhold cranial durchschneidende Zange, 60° aufgebogen, flach, 11,5 x 2,5 mm 1x Herberhold cranial throughcutting forceps, 60° curved upwards, flat, 11.5 x 2.5 mm
20-305-18	1x Freer Doppellevatorium, scharf/stumpf 1x Freer elevator, double ended, sharp/blunt	30-308-01	1x Antrumstanze, links schneidend 1x Antrum punch, left cutting
30-155-50	1x Antrum Trokar, schnabelförmig, 5 mm AD 1x Antrum trocar, beaked, 5 mm OD	30-308-02	1x Antrumstanze, rechts schneidend 1x Antrum punch, right cutting
30-200-01	1x Sichelmesser, gerader Schaft, spitz 1x Sickle knife, straight shaft, pointed	30-422-45	1x Rundkopfstanze für Keilbeinhöhle, 0°, 4,5 mm, mit Spülkanal 1x Sphenoid sinus circular punch, 0°, 4.5 mm, with irrigation channel
30-205-02	1x Antrum-Löffel, längsoval, klein, 2,5 x 6,0 mm, 45° 1x Antrum curette, oval, small, 2.5 x 6.0 mm, 45°	30-425-45	1x Stirnhöhlen-Stanze, aufgebogen, stumpfes Ende, mit Spülkanal, 4,5 mm 1x Frontal sinus punch, curved upwards, blunt end, with irrigation channel, 4.5 mm
30-205-06	1x Stirnhöhlen-Löffel, gerader Schaft, längsoval, 90° aufgebogen 1x Frontal sinus curette, straight shaft, oval, 90° upcurved		
30-203-01	1x Antrum-Kürette, gerader Schaft, vorwärts schneidend 1x Antrum curette, straight shaft, forward cutting		
30-203-02	1x Antrum-Kürette, gerader Schaft, rückw. schneidend 1x Antrum curette, straight shaft, backward cutting		
30-410-01	1x Stirnhöhlen Biopsiezange, 70°, 3 mm, vertikal, mit Spülkanal 1x Frontal sinus biopsy forceps, 70°, 3 mm, vertical, with irrigation channel		
30-411-01	1x Stirnhöhlen Biopsiezange, 110°, 3 mm, vertikal, mit Spülkanal 1x Frontal sinus biopsy forceps, 110°, 3 mm, vertical, with irrigation channel		
30-311-02	1x Kieferhöhlen Polypen-Fasszange, rückwärts öffnend, drehbar 1x Antrum polyp grasping forceps, retrograde opening, rotatable		
30-207-01	1x Stirnhöhlen-Sonde, doppelseitig, leicht gebogen, 19 cm 1x Frontal sinus seeker, double ended, slightly curved, 19 cm		
30-207-02	1x Kieferhöhlensonde, doppelseitig, 19 cm 1x Maxillary sinus seeker, double ended, 19 cm		
30-207-03	1x Stirnhöhlensonde, doppelseitig, stark gebogen, 19 cm 1x Frontal sinus seeker, double ended, strongly curved, 19 cm		
30-402-02	1x Stirnhöhlensonde, durchschneidend, 90°, 2 mm, horizontal 1x Frontal sinus forceps, throughcutting, 90°, 2 mm, horizontal		

#### Ergänzung

#### Supplement

30-160-02	1x Ultra-Stop Antibeschlagmittel, 30 ml, Durchstichflasche, steril 1x Ultra-Stop antifog solution, 30 ml, pierce bottle, sterile
80-661-14	1x Norm-Sterilisations-Container, Boden geschlossen, 585 x 274 x 138 mm 1x Norm sterilization container, bottom closed, 585 x 274 x 138 mm
80-662-00	1x Ventildeckel, silber, für Container 80-661-14, 585 x 278 mm 1x Valve lid, silver, for container 80-661-14, 585 x 278 mm
80-671-60	1x Edelstahl-Siebkorb, Geflecht, Fallgriffe, 485 x 255 x 70 mm 1x Stainless steel wire basket, sliding handles, 485 x 255 x 70 mm
80-681-01	1x Aluminium-Kennzeichnungs-Schild, schwarz, 20 Zeichen 1x Aluminium tag, black, 20 letter

Supplement for sales in EU (outside the EU only on request)

**Bestehend aus / Consisting of:**

20-100-02	1x Hartmann Nasenspekulum für Jugendliche 1x Hartmann nasal speculum for juveniles
30-101-25	1x Eicken Spülröhrchen, lange Biegung, 2,5 mm Durchmesser 1x Eicken antrum cannula, long curve, 2.5 mm diameter
30-102-25	1x Eicken Spülröhrchen, kurze Biegung, 2,5 mm Durchmesser 1x Eicken antrum cannula, short curve, 2.5 mm diameter
30-082-10	1x Frazier Saugrohr, Knopfende, 10 Ch (3,3 mm) 1x Frazier suction tube, ball ended, 10 Fr (3.3 mm)
30-130-00	1x Sinusskop, 187,5 mm AL, 2,7 mm AD, 0° 1x Sinusscope, 187.5 mm length, 2.7 mm OD, 0°
30-130-30	1x Sinusskop, 187,5 mm AL, 2,7 mm AD, 30° 1x Sinusscope, 187.5 mm length, 2.7 mm outer diameter, 30°
30-742-19	1x Draf Sichelmesser, 19 cm, gebogen 1x Draf sickle knife, 19 cm, curved
20-305-18	1x Freer Doppelevatorium, scharf/stumpf 1x Freer elevator, double ended, sharp/blunt
30-207-01	1x Stirnhöhlen-Sonde, doppelseitig, leicht gebogen 1x Frontal sinus seeker, double ended, slightly curved
30-207-02	1x Kieferhöhlen-Sonde, doppelseitig 1x Maxillary sinus seeker, double end
30-205-02	1x Antrum-Löffel, längsoval, klein, 2,5 x 6,0 mm, 45° gewinkelt 1x Antrum curette, oval, small, 2.5 x 6.0 mm, 45° angled
30-205-06	1x Antrum-Löffel, längsoval, klein, 2,5 x 6,0 mm, 90° gewinkelt 1x Antrum curette, oval, small, 2.5 x 6.0 mm, 90° angled
30-122-08	1x Injektionskanüle, kniegebogen, 0,8 mm 1x Injection needle, angled, 0.8 mm
20-215-00	1x Blakesley Nasenzange, gerade, Gr. 0 1x Blakesley nasal forceps, straight, size 0
20-225-00	1x Blakesley Nasenzange, 45° aufgebogen, Gr. 0 1x Blakesley nasal forceps, 45° upcurved, size 0
30-304-15	1x Antrumstanze, rückwärts schneidend, drehbar, 1,5 mm 1x Antrum punch, backward cutting, rotatable, 1.5 mm
30-330-01	1x Wigand durchschneidende Zange, flach, abgerundet, 4,0 x 3,0 mm, gerade, 14 cm 1x Wigand throughcutting forceps, flat, rounded, 4.0 x 3.0 mm, straight, 14 cm
30-330-02	1x Wigand durchschneidende Zange, flach, abgerundet, 4,0 x 3,0 mm, 5° aufgewinkelt, 14 cm 1x Wigand throughcutting forceps, flat, rounded, 4.0 x 3.0 mm, 45° angled, 14 cm
30-407-02	1x Stirnhöhlen Löffelzange, 90°, 2 mm, horizontal, mit Spülkanal 1x Frontal sinus forceps, oval cups, 90°, 2 mm, horizontal, with irrigation channel
30-820-16	1x Draf Siebbeinzängchen, gerade, 4 x 1,8 mm, 16 cm 1x Draf ethmoid forceps, straight, 4 x 1.8 mm, 16 cm

**Ergänzung****Supplement**

30-160-02	1x Ultra-Stop Antibeschlagmittel, 30 ml, Durchstichflasche steril 1x Ultra-Stop antifog solution, 30 ml, pierce bottle, sterile
80-661-14	1x Norm-Sterilisations-Container, Boden geschlossen, 585 x 274 x 138 mm 1x Norm sterilization container, bottom closed, 585 x 274 x 138 mm
80-662-00	1x Ventildeckel, silber, für Container 80-661-14, 585 x 278 mm 1x Valve lid, silver, for container 80-661-14, 585 x 278 mm
80-671-60	1x Edelstahl-Siebkorb, Geflecht, Fallgriffe, 485 x 255 x 70 mm 1x Stainless steel wire basket, sliding handles, 485 x 255 x 70 mm
80-681-04	1x Aluminium-Kennzeichnungs-Schild, grün, 20 Zeichen 1x Aluminium tag, green, 20 letter

Supplement for sales in EU (outside the EU only on request)



## 10 Schädelbasis-Set

### Skull base-Set

#### Bestehend aus / Consisting of:

77HW002	1x Bohrhandstück, gewinkelt, autoklavierbar, 1:1 1x Drill handpiece, angled, autoclavable, 1:1	30-832-16	1x Draf Siebbeinscherchen, gerade, 16 cm 1x Draf ethmoid scissors, straight, 16 cm
BS23509516	1x Bohrerständer für 16 rotierende Instrumente der L= 95 mm 1x Stand for 16 rotary instruments of length 95 mm	30-740-10	1x Draf Mikroraspatorium, 25 cm, 1 mm, leicht gebogen 1x Draf micro raspatory, 25 cm, 1 mm, angled
CR095011206	1x Osteotomie-Bohrer, HM, 95 mm, 1,2 mm, 6 Schneiden 1x Osteotomy bur, TC, 95 mm, 1.2 mm, 6 blades	30-740-30	1x Draf Mikroraspatorium, 25 cm, 3 mm, leicht gebogen 1x Draf micro raspatory, 25 cm, 3 mm, slightly curved
CR095011806	1x Osteotomie-Bohrer, HM, 95 mm, 1,8 mm, 6 Schneiden 1x Osteotomy bur, TC, 95 mm, 1.8 mm, 6 blades	30-740-31	1x Draf Mikroraspatorium, 25 cm, 3 mm, stark gebogen 1x Draf micro raspatory, 25 cm, 3 mm, strongly curved
CR095012306	1x Osteotomie-Bohrer, HM, 95 mm, 2,3 mm, 6 Schneiden 1x Osteotomy bur, TC, 95 mm, 2.3 mm, 6 blades	30-740-40	1x Draf Mikroraspatorium, 25 cm, 4 mm, gewinkelt 1x Draf micro raspatory, 25 cm, 4 mm, angled
CR095014008	1x Osteotomie-Bohrer, HM, 95 mm, 4,0 mm, 8 Schneiden 1x Osteotomy bur, TC, 95 mm, 4.0 mm, 8 blades	30-742-19	1x Draf Sichelmesser, 19 cm, gebogen 1x Draf sickle knife, 19 cm, curved
CR095016014	1x Osteotomie-Bohrer, HM, 95 mm, 6,0 mm, 14 Schneiden 1x Osteotomy bur, TC, 95 mm, 6.0 mm, 14 blades	30-743-19	1x Draf Rundschnittmesser, 19 cm, 1,5 mm 1x Draf round knife, 19 cm, 1.5 mm
DR095011891	1x Diamantbohrer, 95 mm, 1,8 mm mittel 1x Diamond bur, 95 mm, 1.8 mm, medium	30-744-19	1x Draf Incisionsmesser, 19 cm 1x Draf incision knife, 19 cm
DR095012791	1x Diamantbohrer, 95 mm, 2,7 mm mittel 1x Diamond bur, 95 mm, 2.7 mm, medium	30-747-06	1x Frazier Saugrohr, 15 cm, 6 Ch/Fr (2,0 mm) 1x Frazier suction tube, 15 cm, 6 Ch/Fr (2.0 mm)
DR095013591	1x Diamantbohrer, 95 mm, 3,5 mm mittel 1x Diamond bur, 95 mm, 3.5 mm, medium	30-747-08	1x Frazier Saugrohr, 15 cm, 8 Ch/Fr (2,7 mm) 1x Frazier suction tube, 15 cm, 8 Ch/Fr (2.7 mm)
DR095014591	1x Diamantbohrer, 95 mm, 4,5 mm mittel 1x Diamond bur, 95 mm, 4.5 mm, medium	30-748-10	1x Frazier Saugrohr, 15 cm, 10 Ch/Fr (3,3 mm) 1x Frazier suction tube, 15 cm, 10 Ch/Fr (3.3 mm)
DR095016091	1x Diamantbohrer, 95 mm, 6,0 mm mittel 1x Diamond bur, 95 mm, 6.0 mm, medium	30-749-15	1x Saug- und Spülrohr, 17 cm, 2,5 / 2,0 mm 1x Suction/irrigation tube, 17 cm, 2.5 / 2.0 mm
DR095013593	1x Diamantbohrer, 95 mm, 3,5 mm, grob 1x Diamond bur, 95 mm, 3.5 mm, coarse	30-759-21	1x Tönnis Gefäßraspatorium, 21,5 cm 1x Tönnis raspatory, 21.5 cm
DR095016093	1x Diamantbohrer, 95 mm, 6,0 mm, grob 1x Diamond bur, 95 mm, 6.0 mm, coarse	80-125-07	1x Bipolare Koagulationspinzette, NON-STICK, bajonett, Führungsstift 22,5 cm, 0,7 mm 1x Bipolar coagulation forceps, NON-STICK, bayonet, guide pin, 22.5 cm, 0.7 mm
30-700-00	1x Flexibler Spannarm für Spekula, mit Verlängerung 1x Flexible holding arm for specula, incl. holding rods	80-318-50	1x Bipolares Anschlusskabel passend für Erbe/Storz, 5 m 1x Bipolar cable, for Erbe/Storz, 5 m
30-700-01	1x Gelenkkloben zur Befestigung am OP-Tisch 1x Rotation clamp for fixation to operating table		
30-705-55	1x NNH-Spekulum für Erw., 13,5 cm, 55 mm linkes Blatt 1x Sinus speculum f. adults, 13.5 cm, 55 mm left blade		
30-705-75	1x NNH-Spekulum f. Erw., 13,5 cm, 75 mm linkes Blatt 1x Sinus speculum f. adults, 13.5 cm, 75 mm left blade		
30-706-55	1x NNH-Spekulum f. Erw., 13,5 cm, 55 mm rechtes Blatt 1x Sinus speculum f. adults, 13.5 cm, 55 mm right blade		
30-706-75	1x NNH-Spekulum f. Erw., 13,5 cm, 75 mm rechtes Blatt 1x Sinus speculum f. adults, 13.5 cm, 75 mm right blade		
30-820-16	1x Draf Siebbeinzängchen, 4 x 1,8 mm, 16 cm, gerade 1x Draf ethmoid forceps, 4 x 1.8 mm, 16 cm, straight		
30-822-16	1x Draf Siebbeinzängchen, 4 x 1,8 mm, 16 cm, 45° aufgebogen 1x Draf ethmoid forceps, 4 x 1.8 mm, 16 cm, 45° angled		
30-824-16	1x Draf Siebbeinzängchen, 4 x 1,8 mm, 16 cm, 90° aufgebogen 1x Draf ethmoid forceps, 4 x 1.8 mm, 16 cm, 90° angled		
30-826-16	1x Draf Siebbeinzängchen, 3 x 1,5 mm, 16 cm, gerade 1x Draf ethmoid forceps, 3 x 1.5 mm, 16 cm, straight		
30-828-16	1x Draf Siebbeinzängchen, fein gerieft, 16 cm, gerade 1x Draf ethmoid forceps, fine serrated, 16 cm, straight		

#### Ergänzung

#### Supplement

80-661-14	1x Norm-Sterilisations-Container, Boden geschlossen, 585 x 274 x 138 mm 1x Norm sterilization container, bottom closed, 585 x 274 x 138 mm
80-662-00	1x Ventildeckel, silber, für Container 80-661-14, 585 x 278 mm 1x Valve lid, silver, for container 80-661-14, 585 x 278 mm
80-671-60	1x Edelstahl-Siebkorb, Geflecht, Fallgriffe, 485 x 255 x 70 mm 1x Stainless steel wire basket, sliding handles, 485 x 255 x 70 mm
80-681-06	1x Aluminium-Kennzeichnungs-Schild, lila, 20 Zeichen 1x Aluminium tag, purple, 20 letter

Supplement for sales in EU (outside the EU only on request)



## Alphabetisches Inhaltsverzeichnis

Adson-Brown Pinzette.....	20	Kerrison Keilbeinstanze.....	51	Tablettenschale.....	66
Antifog.....	13	Kieferhöhlen Polypen-Fasszange.....	34	Takahashi Nasenzange.....	28, 37
Antrum-Kürette.....	29	Kieferhöhlensonde.....	31	Tellermesser.....	60
Antrum-Löffel.....	29	Killian-Struycken Septumspekulum.....	18	Tobey Mikro-Antrumstanze.....	33
Antrum-Trokar.....	12	Kornzangen-Behälter.....	67	Tönnis Gefäßraspatorium.....	55
Antrumstanze, rückwärts schneidend.....	32 - 33	Knochenstanze mit Reservoir.....	48	Uffenorde Kieferhöhlenlöffel.....	63
Antrumstanze, seitwärts schneidend.....	33	Krause Nasenpolypenschnürer.....	23	Ultra-Stop Antibeschlagmittel.....	12
Binner Polypenfasszange.....	46	Langenbeck Wundhaken.....	65	Walter Schere.....	18
Biopsiezange.....	8, 47	Langenbeck-Green Wundhaken.....	65	Watteträger.....	20
Bipolare Koagulationspinzette.....	56	LED-Leuchtgriff.....	14	Weber Doppelevatorium.....	21
Bipolare Pinzette.....	24	Lichtleitkabel.....	16 - 17	Weber Nasenschere.....	30
Bipolares Anschlusskabel.....	44	Löffelkürette.....	56 - 61	West Flachmeißel.....	63
Blakesley Nasenzange.....	25 - 28, 37 - 39	Löffelzange.....	35	West Hohlmeißel.....	63
Conchotomie Schere.....	30 - 31	Lösungsschale.....	66	Wigand durchschneidende Zange.....	36
Container-Siegel.....	69	Mandrin.....	48	Wigand Polypen-Fasszange.....	27
Cottle Columella-Klemme.....	20	Masing Elevatorium/Raspatorium.....	21	Wigand Stirnhöhlenraspel.....	30
Cottle Hammer.....	22	Masing Ritzmesser.....	21		
Cottle Meißel.....	22	Matrix LED 100 duo.....	16		
Cottle Nasenflügelhaken.....	23	McKenty Keilbeinstanze.....	50		
Cottle Septum-Messer.....	21	Medikamenten-Schälchen.....	67		
Crile-Wood Nadelhalter.....	23	Medizinbecher.....	66		
Desinfektions Wandhalterung für Endoskope.....	17	Metallschale.....	66		
Desinfektions-System für Endoskope.....	17	Middeldorp Wundhaken.....	65		
Dichtigkeitstester für flexible Endoskope.....	16	Mikro-Häkchen.....	61		
Dissektor.....	60	Mukosa Dissektor.....	61		
Dieler bipolare Koagulationszangen.....	41 - 44	Nasenpolypenschlingen.....	23		
Draf Incisionsmesser.....	54	Nasensonde S-förmig.....	23		
Draf Mikroraspatorium.....	54	Nierenschale.....	67		
Draf Rundschnittmesser.....	54	NNH-Spekulum.....	52		
Draf Sichelmesser.....	54	Norm-Sterilisationscontainer.....	68		
Draf Siebbeinscherchen.....	53	Ölspray für Instrumente.....	65		
Draf Siebbeinzängchen.....	53	Orbitaschützer.....	63		
Durchschneidende Nasenzange.....	35	Pädiatrisches FESS-SET.....	71		
Durchschneidende Saugzange.....	36	Petrischale.....	66		
Eicken Spülröhrchen.....	5	Porzellan-Schälchen.....	67		
Endoskope.....	9 - 11	Raspatorium.....	59		
Enucleator.....	59	Reynolds Schere.....	18 - 19		
FESS-Basis-Set.....	70	Ritter Stirnhöhlenbougie.....	8		
Fiberglas-Lichtleitkabel.....	16 - 17	Ringkürette.....	60		
Fisch Wundsperrer.....	56	Rundkopfstanze für Keilbeinhöhle.....	47 - 48		
Flexible Alligator-Fasszange.....	16	Rundkopfstanze für Stirnhöhle.....	45		
Flexible Löffelzange.....	35	Saug- und Spülhandgriff.....	13		
Flexibler Spannarm.....	52	Saug- und Spülrohr.....	55		
Flexibles Endoskop.....	15 - 16	Schädelbasis-Set.....	72		
Frazier Saugrohr.....	6, 55	Schwager Stanze.....	49		
Freer Doppelevatorium.....	21	Sewall Kieferhöhlenelevatorium.....	63		
Gelenkkloben.....	52	Sichelmesser.....	29, 58		
Grünwald Rohrschaftzange.....	40	Siebkorb.....	68		
Guillen Saugraspatorium.....	21	Sinuskop.....	9 - 11		
Haken.....	59	Sondenhäkchen.....	59		
Handgriff für Endoskope.....	13	Sterilisations-System "InstruSafe".....	69		
Hammer.....	22	Sternberg Lippenhaken.....	65		
Hajek-Kofler Keilbeinstanze.....	49 - 50	Stirnhöhlen Biopsiezange.....	47		
Halle Kieferhöhlenkürette.....	63	Stirnhöhlen Löffel.....	30		
Halle Kieferhöhlenlöffel.....	63	Stirnhöhlenlöffelzange.....	46		
Hartmann Nasenspekulum.....	5	Stirnhöhlensaugraspatorium.....	7		
Hartmann Nasentamponadezange.....	27	Stirnhöhlensaugrohr.....	7		
Herberhold cranial durchschneidende Zange.....	36	Stirnhöhlensonde.....	31		
Hochleistungs-Fiberglas-Lichtleitkabel.....	16 - 17	Stirnhöhlenstanze.....	45		
Indikator-Klebeetikett.....	69	Stirnhöhlenzange.....	47		
Injektionskanüle.....	8	Strümpel-Voss Nasenzange.....	27		
Jansen Nasenpinzette.....	20	Spiegel.....	62		
Joseph Schere.....	18 - 19	Spiegel-Griff.....	62		

Adhesive indicator label.....	69	Herberhold cranial throughcutting forceps .....	36	Tönnis raspatory.....	55
Adson-Brown forceps .....	20	High definition fibre light cable .....	16-17	Throughcutting nasal forceps.....	35
Antifog.....	13	Hook.....	59	Throughcutting suction forceps.....	36
Antrum curette.....	29	Injection needle .....	8	Uffnerde antrum curette .....	63
Antrum polyp grasping forceps.....	34	Jansen nasal forceps.....	20	Ultra-Stop anti-fog solution .....	12
Antrum punch with collector.....	48	Joseph scissors.....	18 - 19	Valve lid for norm sterilization container.....	68
Antrum punch .....	32 - 33, 48	Kerrison sphenoid punch .....	51	Walter scissors.....	18
Antrum trocar.....	12	Kidney bowl.....	67	Weber elevator .....	21
Basket.....	64, 68	Killian-Struycken septum speculum .....	18	Weber nasal scissors.....	30
Binner polyp forceps.....	46	Krause nasal polyp snare .....	23	West chisel.....	63
Biopsy forceps .....	8, 47	Langenbeck-Green retractor.....	65	West gouge.....	63
Bipolar cable.....	44	Langenbeck retractor.....	65	Wigand frontal sinus rasp.....	30
Bipolar coagulation forceps.....	56	Leak tester for flexible endoscopes .....	16	Wigand polyp grasping forceps.....	27
Bipolar forceps .....	24	LED light handles .....	14	Wigand throughcutting forceps .....	36
Blakesley nasal forceps.....	25 - 28, 37 - 39	Mallet.....	22		
China bowl .....	67	Masing elevator/raspatory.....	21		
Coding labels.....	68	Masing pointed knife .....	21		
Container seal.....	69	Matrix LED 100 duo.....	16		
Cottle alar retractor.....	23	Maxillary sinus probe .....	31		
Cottle chisel.....	22	McKenty sphenoid punch.....	50		
Cottle columella forceps.....	20	Medicine cup .....	66		
Cottle mallet.....	22	Medication dish.....	67		
Cottle septum knife.....	21	Metal bowl .....	66		
Cotton carrier .....	20	Micro hook .....	61		
Crile-Wood needleholder .....	23	Middeldorpf antrum retractor.....	65		
Cup forceps.....	35	Mirror.....	62		
Dissector.....	60	Mirror handle .....	62		
Dieler bipolar Coagulation forceps.....	41 - 44	Mucosa dissector .....	61		
Disinfection wall holder for endoscopes.....	17	Nasal conchotomy scissors.....	30 - 31		
Draf ethmoid forceps.....	53	Nasal polyp snare wires .....	23		
Draf ethmoid scissors.....	53	Nasal probe .....	23		
Draf flap knife .....	54	Norm sterilization container .....	68		
Draf micro raspatory .....	54	Oil spray for instruments.....	65		
Draf round knife .....	54	Orbita protector .....	63		
Draf sickle knife.....	54	Pediatric FESS-Set.....	71		
Eicken antrum cannula.....	5	Petri dish .....	66		
Endoscope.....	9 - 11	Probe hook.....	59		
Endoscope container with lid.....	69	Raspatory .....	59		
Endoscope handle.....	12	Reynolds scissors.....	18 - 19		
Endoscope sterilizing/protecting tray .....	11	Ring curette .....	60		
Enucleator .....	59	Ritter frontal sinus bougie.....	8		
FESS-Basic-Set .....	70	Rotation clamp for fixation to operating table...	52		
Fibre light cable.....	16 - 17	Schwager punch .....	49		
Fisch Retractor .....	56	Separator.....	60		
Flexible alligator forceps .....	16	Sewall antrum elevator.....	63		
Flexible endoscope.....	15 - 16	Sickle knife.....	29, 58		
Flexible holding arm .....	52	Sinus speculum for adults .....	52		
Forceps holder.....	67	Sinus speculum for children.....	52		
Frazier suction tube.....	6, 55	Sinus suction tube.....	7		
Freer double elevator .....	21	Sinuscope.....	9 - 11		
Frontal sinus biopsy forceps.....	47	Solution bowl.....	66		
Frontal sinus circular punch .....	45	Skull base Set.....	72		
Frontal sinus curette.....	30	Sphenoid sinus circular punch .....	47 - 48		
Frontal sinus forceps.....	46	Spoon curette.....	56 - 61		
Frontal sinus punch.....	45	Sterilizing system "Instru Safe" .....	69		
Frontal sinus probe .....	31	Sternberg lip retractor.....	65		
Frontal sinus suction raspatory .....	7	Strümpel-Voss nasal forceps.....	27		
Frontal sinus suction tube.....	7	Stylet .....	48		
Grünwald tubular forceps.....	40	Suction/Irrigation tube.....	55		
Guillen suction raspatory .....	21	Suction and irrigation handle .....	13		
Hajek-Kofler sphenoid punch .....	49 - 50	Tablet dish .....	66		
Halle antrum curette.....	63	Takahashi nasal forceps.....	28		
Hartmann nasal dressing forceps .....	27	Takahashi suction forceps.....	37		
Hartmann nasal speculum .....	5	Tobey micro antrum punch.....	33		



## Numerisches Inhaltsverzeichnis

### Numeric Content

00-108-005.....	65	20-500-13.....	21	30-082-15.....	6	30-205-01.....	29	30-352-01.....	39
10-468-17.....	56	20-501-14.....	21	30-084-01.....	6	30-205-02.....	29	30-352-02.....	39
20-100-01.....	5	20-502-14.....	21	30-084-02.....	6	30-205-03.....	29	30-354-01.....	39
20-100-02.....	5	20-560-14.....	23	30-100-25.....	5	30-205-04.....	30	30-354-02.....	39
20-150-40.....	18	20-601-14.....	18	30-100-30.....	5	30-205-06.....	30	30-358-00.....	39
20-150-55.....	18	20-610-15.....	18	30-100-40.....	5	30-205-70.....	30	30-358-01.....	39
20-150-65.....	18	20-630-10.....	18	30-101-25.....	5	30-207-01.....	31	30-358-02.....	39
20-150-75.....	18	20-635-15.....	19	30-101-30.....	5	30-207-02.....	31	30-360-00.....	39
20-150-90.....	18	20-635-18.....	19	30-101-40.....	5	30-207-03.....	31	30-360-01.....	39
20-190-25.....	23	20-640-14.....	19	30-102-25.....	5	30-209-01.....	30	30-360-02.....	39
20-195-35.....	23	20-641-14.....	19	30-102-30.....	5	30-300-01.....	32	30-370-15.....	40
20-200-16.....	27	20-690-01.....	30	30-102-40.....	5	30-300-02.....	32	30-370-20.....	40
20-200-20.....	27	20-690-02.....	30	30-105-06.....	6	30-300-03.....	32	30-370-25.....	40
20-215-00.....	26	20-690-03.....	30	30-105-08.....	6	30-302-01.....	32	30-370-30.....	40
20-215-01.....	26	20-691-01.....	30	30-105-10.....	6	30-302-02.....	32	30-371-15.....	40
20-215-02.....	26	20-693-00.....	31	30-106-25.....	7	30-302-03.....	32	30-371-20.....	40
20-215-03.....	26	20-693-01.....	31	30-106-30.....	7	30-304-15.....	33	30-371-25.....	40
20-215-04.....	26	20-693-02.....	31	30-106-40.....	7	30-304-25.....	33	30-371-30.....	40
20-215-10.....	26	20-700-10.....	20	30-108-00.....	7	30-305-00.....	33	30-372-15.....	40
20-215-12.....	26	20-710-12.....	20	30-121-25.....	8	30-306-00.....	33	30-372-20.....	40
20-215-14.....	26	20-713-12.....	20	30-121-30.....	8	30-307-00.....	33	30-372-25.....	40
20-225-00.....	26	20-730-16.....	20	30-122-08.....	8	30-308-01.....	33	30-373-15.....	40
20-225-01.....	26	20-730-19.....	20	30-125-00.....	8	30-308-02.....	33	30-373-20.....	40
20-225-02.....	26	20-730-21.....	20	30-129-00.....	10	30-310-01.....	34	30-373-25.....	40
20-225-03.....	26	20-740-15.....	23	30-129-30.....	10	30-310-02.....	34	30-374-20.....	40
20-225-04.....	26	20-800-16.....	20	30-130-00.....	10	30-311-01.....	34	30-375-20.....	40
20-225-11.....	26	20-801-16.....	20	30-130-30.....	10	30-311-02.....	34	30-376-20.....	40
20-225-12.....	26	20-802-16.....	20	30-130-70.....	10	30-320-01.....	35	30-400-00.....	45
20-225-14.....	26	20-915-00.....	25	30-132-00.....	11	30-320-02.....	35	30-400-01.....	45
20-235-01.....	26	20-915-01.....	25	30-132-30.....	11	30-321-01.....	35	30-401-01.....	47
20-235-02.....	26	20-915-02.....	25	30-132-45.....	11	30-321-02.....	35	30-401-02.....	47
20-235-03.....	26	20-915-03.....	25	30-134-00.....	11	30-322-01.....	35	30-402-01.....	47
20-236-00.....	27	20-915-04.....	25	30-134-30.....	11	30-322-02.....	35	30-402-02.....	47
20-238-00.....	27	20-915-10.....	25	30-134-45.....	11	30-328-01.....	35	30-404-01.....	46
20-240-01.....	28	20-915-12.....	25	30-134-70.....	11	30-330-01.....	36	30-404-02.....	46
20-240-02.....	28	20-925-00.....	25	30-135-00.....	10	30-330-02.....	36	30-405-01.....	46
20-240-11.....	28	20-925-01.....	25	30-135-30.....	10	30-332-01.....	36	30-405-02.....	46
20-240-12.....	28	20-925-02.....	25	30-142-45.....	10	30-332-02.....	36	30-405-11.....	46
20-245-01.....	28	20-925-03.....	25	30-142-90.....	10	30-333-01.....	36	30-405-12.....	46
20-245-02.....	28	20-925-04.....	25	30-143-00.....	10	30-333-02.....	36	30-407-01.....	46
20-245-11.....	28	20-935-01.....	25	30-143-30.....	10	30-340-01.....	37	30-407-02.....	46
20-245-12.....	28	20-935-02.....	25	30-143-70.....	10	30-340-02.....	37	30-408-01.....	46
20-246-01.....	28	20-945-01.....	28	30-151-27.....	12	30-340-03.....	37	30-408-02.....	46
20-246-02.....	28	20-945-02.....	28	30-151-40.....	12	30-342-01.....	37	30-410-01.....	47
20-300-21.....	21	20-946-01.....	28	30-155-50.....	12	30-342-02.....	37	30-410-02.....	47
20-305-18.....	21	20-946-02.....	28	30-156-33.....	12	30-342-03.....	37	30-411-01.....	47
20-306-20.....	21	30-080-05.....	6	30-156-40.....	12	30-343-01.....	38	30-411-02.....	47
20-307-18.....	21	30-080-06.....	6	30-156-50.....	12	30-343-02.....	38	30-415-01.....	46
20-313-00.....	23	30-080-07.....	6	30-160-01.....	12	30-343-03.....	38	30-415-02.....	46
20-320-19.....	7	30-080-08.....	6	30-160-02.....	12	30-343-04.....	38	30-421-35.....	45
20-322-01.....	21	30-080-09.....	6	30-160-03.....	12	30-343-11.....	38	30-421-45.....	45
20-322-02.....	21	30-080-10.....	6	30-160-05.....	13	30-343-12.....	38	30-422-35.....	48
20-322-03.....	21	30-080-12.....	6	30-161-00.....	13	30-343-13.....	38	30-422-45.....	48
20-323-01.....	21	30-080-15.....	6	30-169-08.....	16	30-343-14.....	38	30-425-35.....	46
20-323-02.....	21	30-081-06.....	7	30-172-40.....	16	30-344-00.....	36	30-425-45.....	46
20-323-03.....	21	30-081-08.....	7	30-173-40.....	16	30-344-45.....	36	30-428-35.....	45
20-400-18.....	22	30-081-09.....	7	30-175-40.....	16	30-346-00.....	37	30-428-45.....	45
20-404-20.....	22	30-081-10.....	7	30-200-01.....	29	30-346-30.....	37	30-429-35.....	47
20-405-04.....	22	30-081-12.....	7	30-200-02.....	29	30-350-00.....	39	30-429-45.....	47
20-405-07.....	22	30-081-15.....	7	30-200-03.....	29	30-350-01.....	39	30-450-20.....	48
20-405-09.....	22	30-082-08.....	6	30-200-04.....	29	30-350-02.....	39	30-450-30.....	48
20-405-10.....	22	30-082-10.....	6	30-203-01.....	29	30-350-03.....	39	30-450-90.....	48
20-405-12.....	22	30-082-12.....	6	30-203-02.....	29	30-352-00.....	39	30-454-20.....	50



30-456-32.....	49	30-700-01.....	52	30-943-12.....	25	80-308-15.....	65	80-662-01.....	68	90-212-03.....	61
30-468-10.....	51	30-702-25.....	52	30-943-13.....	25	80-308-20.....	65	80-662-02.....	68	90-213-00.....	61
30-468-20.....	51	30-703-25.....	52	70-203-00.....	16	80-316-50.....	24	80-662-03.....	68	90-214-00.....	61
30-468-30.....	51	30-705-55.....	52	70-211-00.....	14	80-317-30.....	24	80-662-04.....	68	90-215-00.....	61
30-468-40.....	51	30-705-65.....	52	70-211-01.....	14	80-317-50.....	24	80-662-05.....	68	90-220-00.....	62
30-468-50.....	51	30-705-75.....	52	70-211-10.....	14	80-319-30.....	24	80-671-20.....	68	90-222-04.....	62
30-469-10.....	51	30-706-55.....	52	70-211-20.....	14	80-319-50.....	24	80-671-25.....	68	90-222-05.....	62
30-469-20.....	51	30-706-65.....	52	70-211-30.....	14	80-320-30.....	44	80-671-40.....	68	90-222-06.....	62
30-469-30.....	51	30-706-75.....	52	70-211-40.....	14	80-321-30.....	44	80-671-60.....	68	90-222-08.....	62
30-469-40.....	51	30-740-10.....	54	70-211-50.....	14	80-322-30.....	44	80-681-01.....	68	90-222-10.....	62
30-469-50.....	51	30-740-30.....	54	70-258-35.....	17	80-324-40.....	44	80-681-02.....	68	90-222-12.....	62
30-471-10.....	51	30-740-31.....	54	70-258-48.....	17	80-334-16.....	65	80-681-03.....	68	130 400 028ST.....	15
30-471-20.....	51	30-740-40.....	54	70-259-35.....	17	80-501-01.....	66	80-681-04.....	68	130 400 034ST.....	15
30-471-30.....	51	30-742-19.....	54	70-259-48.....	17	80-501-02.....	66	80-681-05.....	68	130 400 040ST.....	15
30-473-10.....	51	30-743-19.....	54	70-260-35.....	17	80-501-03.....	66	80-681-06.....	68		
30-473-20.....	51	30-744-19.....	54	70-260-48.....	17	80-501-04.....	66	80-681-07.....	69		
30-473-30.....	51	30-747-06.....	55	70-265-01.....	17	80-503-03.....	66	80-683-10.....	69		
30-475-01.....	49	30-747-07.....	55	70-265-02.....	17	80-504-05.....	66	80-684-10.....	69		
30-475-02.....	49	30-747-08.....	55	70-266-02.....	17	80-506-30.....	66	80-688-00.....	69		
30-477-10.....	51	30-747-09.....	55	70-267-03.....	16	80-507-40.....	66	80-690-01.....	69		
30-477-20.....	51	30-747-10.....	55	70-470-00.....	17	80-509-75.....	66	80-690-02.....	69		
30-477-30.....	51	30-747-12.....	55	70-472-00.....	17	80-512-00.....	66	80-691-01.....	69		
30-477-40.....	51	30-747-15.....	55	80-090-00.....	42	80-515-06.....	66	80-692-01.....	69		
30-477-50.....	51	30-749-15.....	55	80-090-01.....	42	80-515-08.....	66	90-201-01.....	56		
30-477-60.....	51	30-759-21.....	55	80-090-02.....	44	80-515-10.....	66	90-201-02.....	57		
30-478-10.....	51	30-805-00.....	63	80-090-03.....	43	80-517-00.....	66	90-201-03.....	57		
30-478-20.....	51	30-807-01.....	63	80-090-04.....	43	80-519-00.....	67	90-201-04.....	57		
30-478-30.....	51	30-807-02.....	63	80-090-05.....	43	80-519-01.....	67	90-201-05.....	57		
30-478-40.....	51	30-807-03.....	63	80-090-07.....	42	80-519-02.....	67	90-201-06.....	57		
30-478-50.....	51	30-809-01.....	63	80-090-08.....	43	80-519-03.....	67	90-201-07.....	57		
30-478-60.....	51	30-809-02.....	63	80-090-09.....	43	80-520-06.....	67	90-201-08.....	57		
30-479-10.....	51	30-812-24.....	63	80-090-10.....	43	80-520-08.....	67	90-201-09.....	57		
30-479-20.....	51	30-814-19.....	63	80-090-11.....	43	80-525-17.....	67	90-201-14.....	58		
30-479-30.....	51	30-816-40.....	63	80-090-12.....	43	80-525-25.....	67	90-201-15.....	58		
30-479-40.....	51	30-817-40.....	63	80-090-13.....	43	80-528-13.....	67	90-201-16.....	58		
30-479-50.....	51	30-820-10.....	53	80-090-14.....	43	80-528-18.....	67	90-201-17.....	58		
30-479-60.....	51	30-820-13.....	53	80-090-15.....	43	80-528-20.....	67	90-201-18.....	58		
30-483-10.....	51	30-820-16.....	53	80-090-16.....	43	80-530-20.....	67	90-201-19.....	58		
30-483-20.....	51	30-820-19.....	53	80-090-17.....	43	80-611-10.....	69	90-201-28.....	58		
30-483-30.....	51	30-822-13.....	53	80-110-16.....	24	80-621-05.....	11	90-201-29.....	58		
30-483-40.....	51	30-822-16.....	53	80-125-03.....	56	80-622-56.....	11	90-202-01.....	58		
30-483-50.....	51	30-822-19.....	53	80-125-07.....	56	80-623-22.....	11	90-202-02.....	58		
30-483-60.....	51	30-824-13.....	53	80-125-12.....	56	80-631-10.....	68	90-204-01.....	59		
30-484-10.....	51	30-824-16.....	53	80-126-23.....	24	80-631-12.....	68	90-204-02.....	59		
30-484-20.....	51	30-824-19.....	53	80-260-12.....	64	80-631-14.....	68	90-206-01.....	59		
30-484-30.....	51	30-826-16.....	53	80-260-35.....	64	80-631-21.....	68	90-206-02.....	59		
30-484-40.....	51	30-828-16.....	53	80-260-42.....	64	80-632-00.....	68	90-206-03.....	59		
30-484-50.....	51	30-828-19.....	53	80-261-35.....	64	80-632-01.....	68	90-206-04.....	59		
30-484-60.....	51	30-829-16.....	53	80-261-42.....	64	80-632-02.....	68	90-208-01.....	59		
30-485-10.....	51	30-832-13.....	53	80-262-12.....	64	80-632-03.....	68	90-208-02.....	59		
30-485-20.....	51	30-832-16.....	53	80-275-11.....	64	80-632-04.....	68	90-210-01.....	59		
30-485-30.....	51	30-832-19.....	53	80-275-23.....	64	80-632-05.....	68	90-210-02.....	59		
30-485-40.....	51	30-833-16.....	53	80-275-40.....	64	80-641-14.....	68	90-210-03.....	60		
30-485-50.....	51	30-834-16.....	53	80-275-50.....	64	80-642-00.....	68	90-210-04.....	60		
30-485-60.....	51	30-835-19.....	53	80-280-01.....	64	80-642-01.....	68	90-210-05.....	60		
30-485-10TAN.....	51	30-900-00.....	70	80-302-12.....	65	80-642-02.....	68	90-210-06.....	60		
30-485-40TAN.....	51	30-902-00.....	72	80-302-14.....	65	80-642-03.....	68	90-210-07.....	60		
30-490-40.....	50	30-905-00.....	71	80-302-16.....	65	80-642-04.....	68	90-210-08.....	60		
30-491-40.....	50	30-943-01.....	25	80-306-17.....	65	80-642-05.....	68	90-210-09.....	60		
30-492-40.....	50	30-943-02.....	25	80-306-22.....	65	80-661-12.....	68	90-210-10.....	60		
30-493-40.....	50	30-943-03.....	25	80-306-30.....	65	80-661-14.....	68	90-211-01.....	60		
30-494-40.....	50	30-943-04.....	25	80-308-07.....	65	80-661-21.....	68	90-212-01.....	61		
30-700-00.....	52	30-943-11.....	25	80-308-10.....	65	80-662-00.....	68	90-212-02.....	61		



## Umrechnungstabelle - Ch/Fr - mm - inch

### Conversion table - Ch/Fr - mm - inch

Charrière (CH) French (F)	mm	Inch
1	0,33	0,013
2	0,67	0,025
3	1,00	0,039
4	1,33	0,051
5	1,67	0,065
6	2,00	0,079
7	2,33	0,092
8	2,67	0,105
9	3,00	0,118
10	3,33	0,131
11	3,67	0,144
12	4,00	0,156
13	4,33	0,170
14	4,67	0,184
15	5,00	0,197
16	5,33	0,210
17	5,67	0,223
18	6,00	0,237
19	6,33	0,249
20	6,67	0,263
21	7,00	0,276
22	7,33	0,288
23	7,67	0,302
24	8,00	0,315
25	8,33	0,328
26	8,67	0,341
27	9,00	0,354
28	9,33	0,367
29	9,67	0,380
31	10,23	0,407
32	10,67	0,420
34	11,33	0,446
36	12,00	0,472
38	12,67	0,494
40	13,33	0,520
45	15,00	0,591



© 2023 by SPIGGLE & THEIS Medizintechnik GmbH

Änderungen und Irrtümer – einschließlich Bilder - vorbehalten.  
Produktsortiment kann pro Land abweichen.

Modifications and errors – including pictures – reserved.  
Product range might vary per country.



Burghof 14 · 51491 Overath · Germany  
Phone: +49 2206 90 81 - 0  
Fax: +49 2206 90 81 - 13  
info@spiggle-theis.com  
www.spiggle-theis.com